

Contents

1. INTRODUCTION FOR INSTALLATION MANUAL.....	2
1.1. DISCLAIMER.....	2
1.2. LIMITATION OF LIABILITY	2
2. SAFETY PRECAUTIONS.....	2
2.1. WARNING.....	2
2.2. GENERAL SAFETY.....	2
2.3. HANDLING SAFETY	3
3. UNLOAD/TRANSPORTATION/STORAGE.....	4
3.1. MARKERS ON OUTER PACKAGING	5
3.2. UNLOADING WARNING	6
3.3. SECONDARY TRANSPORT AND WARNING	7
3.4. STORAGE	8
4. UNPACKING SAFETY.....	8
5. INSTALLATION	9
5.1. INSTALLATION SAFETY	9
5.2. ENVIRONMENT CONDITIONS AND SITE SELECTION	10
5.3. TILT ANGLE OF INSTALLATION	13
5.4. INSTALLATION REQUIREMENTS FOR BIFACIAL CELLS MODULE	14
5.5. INSTALLATION METHOD	15
5.5.1.MECHANICAL INSTALLATION AND WARNING	15
5.5.2.ELECTRICAL INSTALLATION	19
6. MODULE MAINTENANCE.....	23
6.1. PANEL VISUAL INSPECTION AND REPLACEMENT.....	24
6.2. CONNECTOR AND CABLE INSPECTION	24
6.3. CLEANING.....	25
6.3.1.MODULE INSPECTION AFTER CLEANING	26
6.3.2.TROUBLESHOOTING	26

1. INTRODUCTION FOR INSTALLATION MANUAL

This INSTALLATION MANUAL applies to Topco Solar Inc and its cooperated or affiliated companies. Each cooperated or affiliated companies includes but not limited to Topco Solar Inc. This INSTALLATION MANUAL applies to the installation, maintenance, and using of the single glass solar modules manufactured by Topco Solar Inc and its cooperated or affiliated companies (hereinafter referred to as “Topco Solar”), including but not limited to the following product models: **(TPM7-SH108-410/M, TPM7-SHDB144-550/M.)**. Failure to follow these INSTALLATION MANUAL could result in personal injury or property damage.

Installation and operation of PV modules requires professional skills and should only be performed by qualified professionals. Please read the “Safety and Installation Instructions” carefully before using and operating the modules.

The word “module” or “PV module” used in this manual refers to one or more single glass solar modules.

Please keep this manual for future reference.

1.1. DISCLAIMER

- 1) Topco Solar Inc reserves the rights to change this installation manual without prior notice. Please refer to our product lists and documents published on our website at: <https://www.topcosolar.com/> as these lists are updated on a regular basis.
- 2) Failure of the customer to follow the requirements outlined in this Manual during the installation (including without limitation to packing/unpacking, loading/unloading, transportation, storage, installation, use, operation or maintenance, etc.) of the module will result in the invalidity of product's limited warranty.
- 3) Topco Solar is not responsible for any infringement of third party patents or any other rights arising from the use of solar PV modules.
- 4) The information in this manual is based on Topco Solar’s knowledge and experience and is believed to be reliable, but such information including product specification (without limitations) and suggestions Do not constitute a warranty, expresses or implied.

1.2. LIMITATION OF LIABILITY

Topco Solar is not responsible for any damages of any kind, including but not limited to any product damages, personal injury or any other property losses, as resulting from any improper operations or faults by the customers during the handling of the products as failure to follow the instructions in this Manual.

2. SAFETY PRECAUTIONS

2.1. WARNING

Before attempting to install, wire, operate and/or service the module and other electrical equipment, all instructions should be read and understood. Direct current (DC) is generated when the battery surface of the module is exposed to direct sunlight or other light sources, and direct contact with the live parts of the module, such as terminals, may result in death of personnel whether connected to the module or not.

2.2. GENERAL SAFETY

Topco Solar modules are designed to meet the requirements of IEC 61215 and IEC 61730, Safety Class: class II. Modules rated for use in this application class may be used in system operating at greater than 50V DC or 240W, where general contact access is anticipated. Modules qualified for safety through IEC 61730-1 and IEC 61730-2 and within this application class are considered to meet the requirements for safety class II equipment.

- 1) All installation work must comply with the local codes and the relevant international electrical standards.
- 2) Topco Solar recommends that PV module installation is conducted by personnel who have been professionally trained

in PV system installation. Operation by personnel who are not familiar with the relevant safety procedures will be very dangerous.

- 3) Do not allow unauthorized persons to access the installation area or module storage area.
- 4) Protective clothing (non-slip gloves, clothes, etc.) must be worn during installation to prevent direct contact with 30V DC or greater, and to protect hands from sharp edges.
- 5) Prior to installation, remove all metallic jewelry to prevent accidental exposure to live circuits.
- 6) When installing modules in light rain, morning dew, take appropriate measures to prevent water ingress into the connectors, f. e. using connector endcaps.
- 7) Use electrically insulated tools to reduce the risk of electric shock.
- 8) Do not use or install broken modules.
- 9) External or artificially concentrated sunlight shall not be directed onto the front or back face of the PV module.
- 10) Do not contact module if the front or rear glass is broken. This action may cause electric shock.
- 11) Do not attempt to repair, disassemble, move any part of the PV module. The module does not contain any reusable parts.
- 12) Do not connect or disconnect the module when it is energized or connected with an external power supply.

2.3. HANDLING SAFETY

- 1) Do not stand, walk on or lean on the module directly.

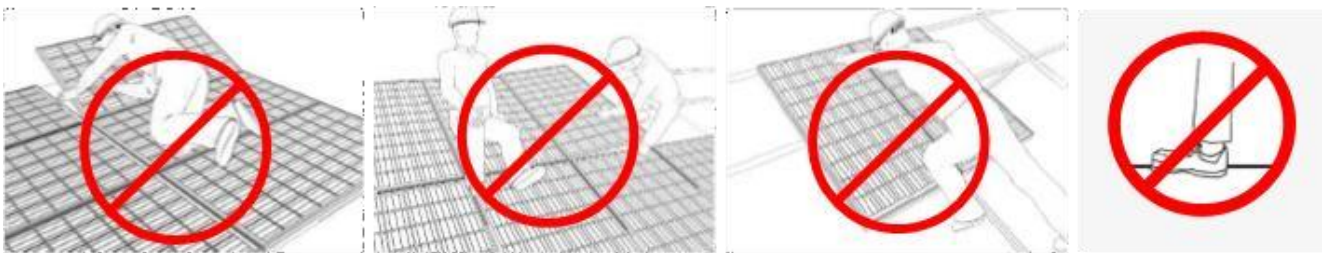

- 2) Do not damage or scratch the front or backside surfaces of the module.
- 3) Do not drag, scratch, bend the output cable with force or with too tight connection. The insulation of output cable can break and may result in electricity leakage or shock.
- 4) If there is an open fire, please extinguish it with a dry powder extinguisher after disconnecting the power supply, cannot use liquid such as water to extinguish the fire.
- 5) Do not install or handle modules under wet, rain, snow or windy conditions. Place disassembled PV modules correctly.
- 6) Take care to keep modules and in particular their electrical contacts, clean and dry before installation. If connector cables are left in damp conditions then the contacts may corrode. Any module with corroded contacts should not be used.
- 7) Please Do not loosen, unscrew or peel the PV module bolts and frame glue. This may lead to a reduction of the module's load rating and potential damage from a fall.
- 8) Do not drop PV modules or allow objects to fall down on the PV modules.
- 9) During installation or under sunlight, it is forbidden to directly touch the junction box, connector, cable and other electrified bodies of the module without any protection, regardless of whether the PV module is connected with the system. There is a risk of scalding or electric shock.
- 10) Do not discard the modules at will; special recycling is required.

3. UNLOAD/TRANSPORTATION/STORAGE

Precautions and general safety rules:

- 1) Modules should be stored in a dry and ventilated environment to avoid direct sunlight and moisture and extra precautions should be taken to prevent connectors from being exposed to moisture or sunlight, like using connector endcaps.
- 2) The modules should be stored in the original Topco Solar package before installation. Protect the package from damage. Unpack the modules as per the recommended unpacking procedures. The whole process of unpacking, transport and storing should be handled with care.
- 3) Unpacking must be carried out by two or more persons at the same time.
- 4) Handling the modules requires two or more people with nonslip gloves and both hands.
- 5) Do not pull the cables, junction boxes or frames to handle modules.
- 6) Do not handle the modules over-head or stack the modules.
- 7) Do not place excessive loads on the module or twist the module.
- 8) Do not drop or place objects (such as tools) on the modules.
- 9) Do not put the modules in a place that is not supported or stable.
- 10) Do not allow the modules to come in contact with sharp-pointed objectives to prevent them from scratches, avoiding a direct impact on the safety of modules.
- 11) Do not expose the modules and its connectors to any chemical substance (e.g., oil, lubricant, pesticide, etc.).
- 12) Before the secondary transportation vehicle is started, it should be bundled with net ropes. The rope should be fastened to prevent damage to the modules during the transportation. If the safety rope is used, the contact part between the safety rope and the carton shall be separated by paper corrugated or other cushioning materials. The speed of the vehicle carrying the modules should be ≤ 5 km/h and ≤ 3 km/h for turning, so as to avoid sudden stop and rapid start.
- 13) In any circumstances, for vertical landscape packages, it shall not be stacked more than two layers; for vertical portrait packages, stacking is not allowed. Example for vertical landscape package and vertical portrait package is shown as follows:



**Vertical landscape package
(short-side vertically placed)**





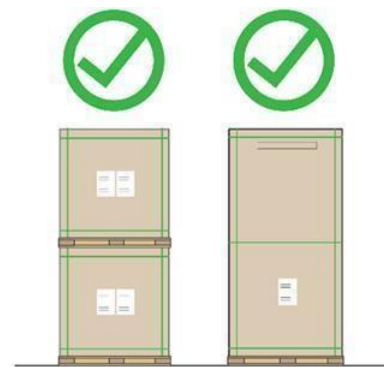



**Vertical portrait package
(long-side vertically placed)**



Right Examples

3.1. MAKERS ON OUTER PACKAGING

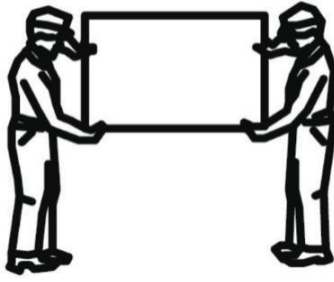
<p>3.1.1. Need both hands to handle it carefully.</p> 	<p>3.1.2. Uninstalled modules must be kept dry, not expose to rain or moisture.</p> 
<p>3.1.3. Modules in carton are fragile, which must be handled with care.</p> 	<p>3.1.4. The packaging must be transported upright.</p> 
<p>3.1.5. Do not step on the package and module.</p> 	<p>3.1.6. Modules shall be stacked as required, not exceeding the maximum number of layers printed on the outer packaging. (no more than two layers).</p> 
<p>3.1.7. One module shall be handled by at least two persons together. Modules are placed vertically.</p> 	

3.2. UNLOADING WARNING

3.2.1. When crane is used to unload the modules, please choose and use specialized tooling according to the weight and size of the module. Before lifting, check whether the pallet and the carton are damaged and whether the hoisting ropes are strong and firm. Please adjust the position of the sling to keep the modules steady. To ensure the safety of the module, wooden sticks, boards or other fixtures of the same width as the outer packing cases should be used on the upper part of the box to prevent the sling from squeezing the pallet and damaging the modules. When placing the modules, do not lower the packing box too quickly. Two people shall support at the two sides of the righting carton gently to place it on a flat ground. **For vertical landscape packages, do not lift up more than FOUR pallets of modules at once; for vertical portrait packages, do not lift up more than TWO pallet of modules at once. Do not unload modules under the weather conditions of wind more than 6 class (in Beaufort scale), heavy rain or heavy snow.**



3.2.2. Use a forklift to remove the module pallets from the truck.

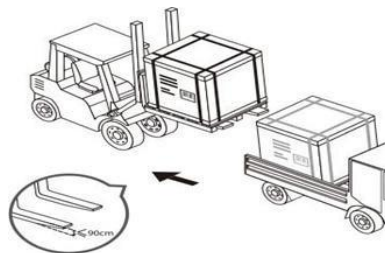

3.2.3. Put the modules on level ground.

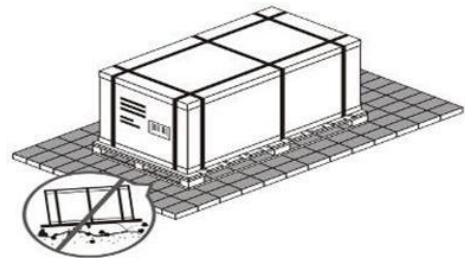

3.2.4. Do not stack the modules at the project site.

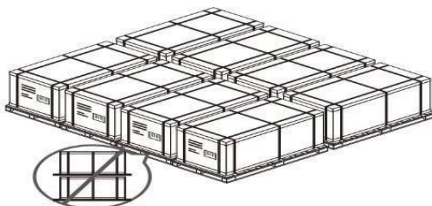

3.2.5. Store the module in a dry and ventilated place.

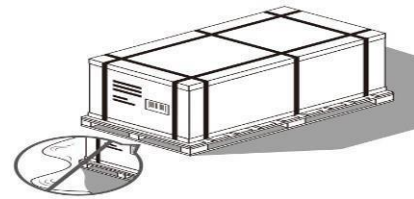

3.2.6. Cover the module with waterproof material to prevent it from moisture.



3.3. SECONDARY TRANSPORT AND WARNING

3.3.1. Do not remove the original packages if the modules require long-distance transport or long-term storage.

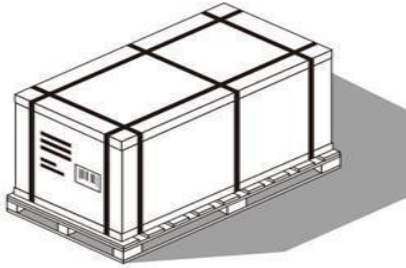

3.3.2. Packaged products can be transported by land, sea or air. During transportation, make sure that the package is fixed securely to the shipping platform without movement. Do not Stack more than two layers on truck.

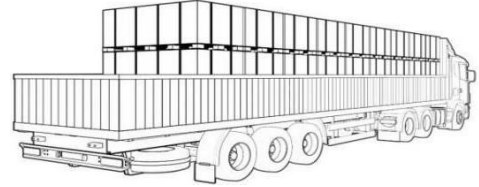

3.3.3. Only one layer stacking is only allowed for transport at the project site

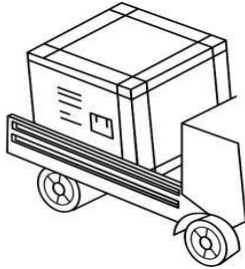

3.3.4. No transport or handling by pedi-cab or improper vehicle as shown below.

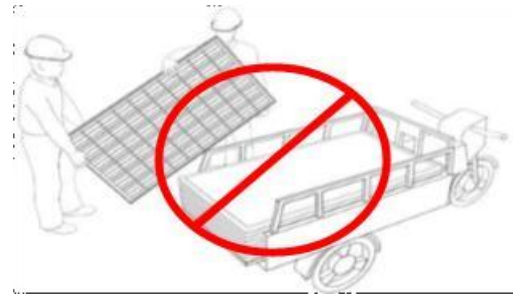

3.3.5. Do not transport the module with rope as shown below.

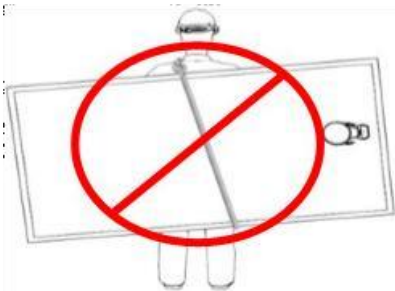

3.3.6. Do not carry the modules on the back of one person as shown below.



3.3.7. Do not allow pallets to exceed the loading area of the transport vehicle.

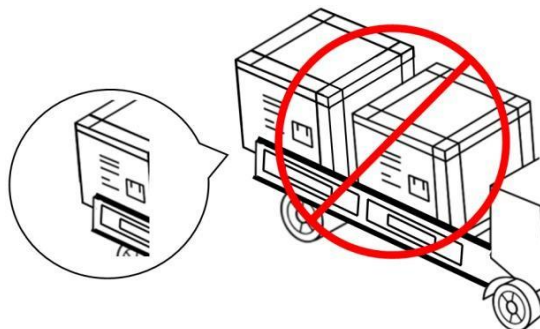

3.4. STORAGE

- 1) Do not remove the original package and keep the wrapping film and carton box in a good condition, if the modules require long-distance transport or long-term storage.
- 2) For long-term storage, it is recommended to store the modules in a standard warehouse with regular inspection, and under confirming of your personal safety, reinforce the package in a timely manner if any anomalies are found.
- 3) Storage in project site warehouse or normal warehouse (moisture < 85%RH, temperature in the range from - 40°C to +50°C): Do not stack different types of PV modules together.
- 4) Do not expose the modules to rain or moisture. Store the finished product in a well ventilated, waterproof, dry and smooth place (for vertically portrait package, the inclination of ground needs to be less than 4°), to avoid damage or dumping of the modules due to ground deformation or collapse. The modules should be centrally stored with pallet spacing within 10cm. And the modules should be covered with waterproof material.
- 5) If you need to store the modules in the project site, do not choose soft ground and the ground that is easy to collapse, should choose a hard ground or a higher ground with flat surface to ensure the module packages not collapsing and tilting for long-term storage.
- 6) The module must be installed as soon as possible in the project site and must not be exposed to rain or damp. Topco Solar shall not be responsible for any damage or collapse of the modules caused by moisture in the packaging.

4. UNPACKING SAFETY

- 1) For unpacking outdoors, it is prohibited to operate in rainy conditions. Because the carton will become soft and damaged after it gets wet in the rain. The stacked PV modules (hereinafter referred to as "modules") may tip over, which may cause damage or injury to personnel.
- 2) For a windy site, it is necessary to pay special attention to safety. Especially, it is not recommended to transport or unpacking the modules in high wind conditions. The unpacked modules must be tied down to avoid any unwanted movement.
- 3) The work surface is required to be level to ensure that the package can be placed stably, avoiding sliding.
- 4) Wear protective gloves during unpacking to avoid hand injury and fingerprints on the glass surface.
- 5) If all the modules are not taken out after unpacking, the remaining modules shall be placed horizontally and repackaged to prevent them from tipping. When packaging, please note that the glass side of the bottom module should face up, the glass side of the middle modules should face down, and the glass side of the top module should face up. Stacks of modules should contain no more than 16 modules, and the frames should be aligned.
- 6) If the unpacked modules are not installed immediately, they should be fixed to the stand supporter with a safety rope under weather of 6 class wind (the modules should be less than 12 pieces).

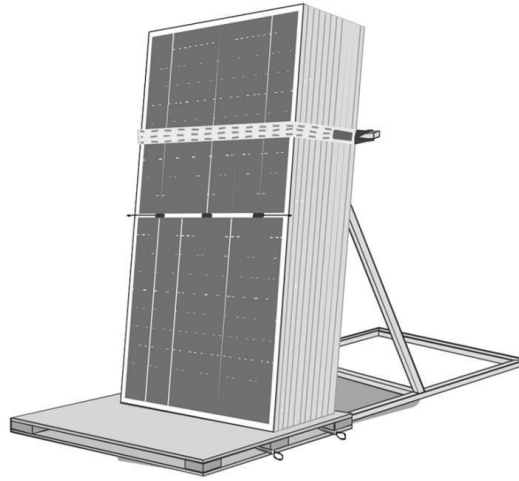

In addition to the above points for attention, consider professional on-site unpacking, exception handling rules, please refer to Topco Solar “Spec. for PV Module Unloading, unpacking and Secondary Transferring”.

5. INSTALLATION

5.1. INSTALLATION SAFETY

- 1) Topco Solar modules can be mounted in landscape or portrait orientation, the impact of dirt shading the solar cells can be minimized by orienting the product in landscape. Please pay attention that the modules can only be installed on vertical racking not horizontal racking when customers choose landscape mode. For all PV modules, Topco Solar does not recommend short side installation.

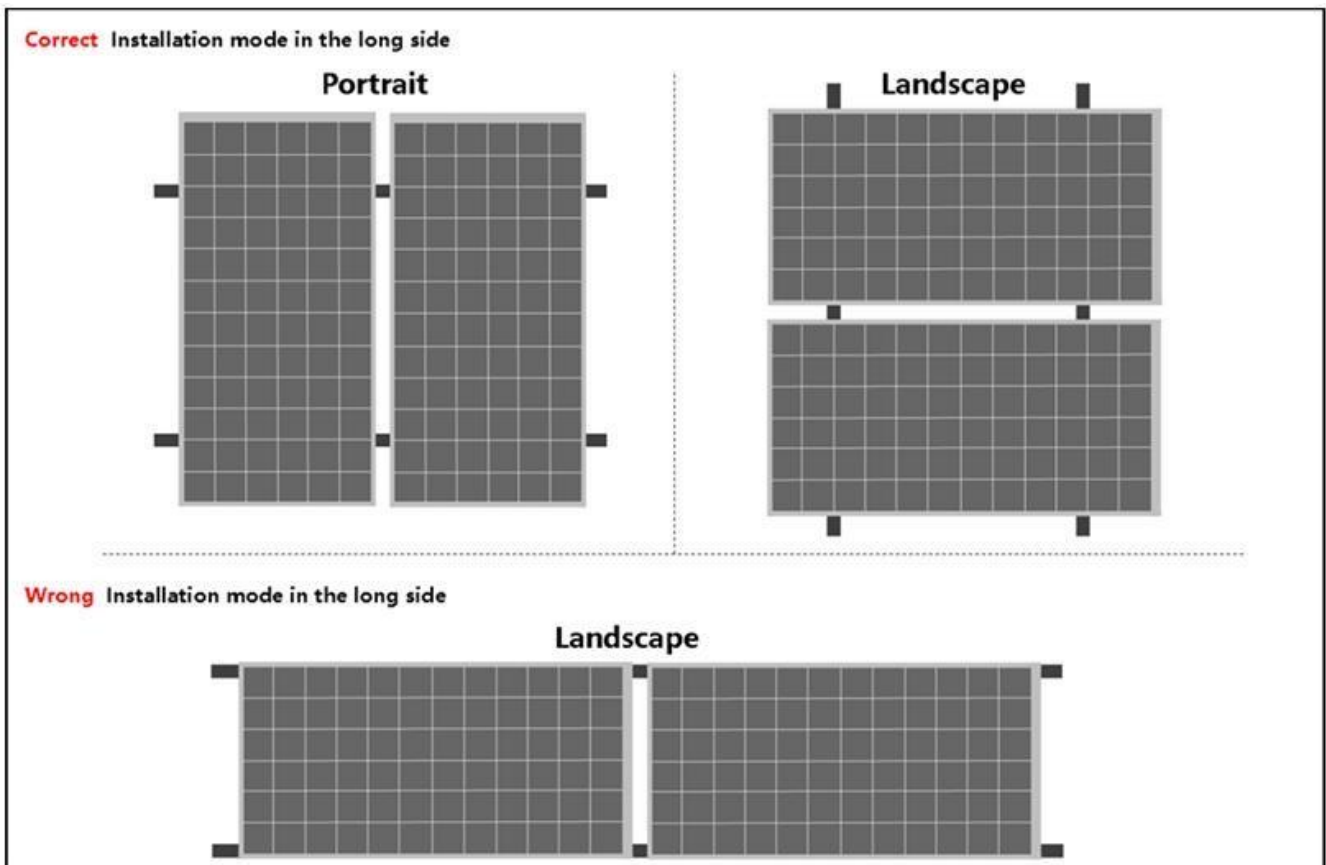

Installation Manual

- 2) Always wear dry insulation protection equipment: insulated tools, head gear, insulated gloves, safety belt and safety shoes (with rubber soles).
- 3) Make sure flammable gasses are not generated or present near the installation site.
- 4) Keep the PV module packed in the carton until installation. Please install immediately after unpacking. Please keep the connector dry and clean during installation to avoid the risk of electric shock. Do not perform any work if the terminals of PV module are wet, until they are dry.
- 5) Please take measures to insulate during PV module installation and wiring.
- 6) Do not hit or put excessive load on the front or back of PV modules, this may break the cells or cause microcracks.
- 7) Do not unplug the connector if the system circuit is connected to a load.
- 8) Do not stand on the module glass. There is a risk of injury or electric shock if glass is broken.
- 9) Do not work alone (always work as a team of 2 or more people).
- 10) Do not damage the back glass of PV modules when fastening the PV modules to a support with bolts.
- 11) Do not drill holes in the frame. It may cause corrosion of the frame or PV modules burst.
- 12) Do not damage the surrounding PV modules or mounting structure when replacing a PV module.
- 13) Cables should be fixed in the area not exposed to direct sunlight to prevent cables aging.
- 14) Protective measures must be taken in the process of installation to avoid force extrusion or impact on the modules.
- 15) The open area should minimize arc coil, which can reduce the risk of induced lightning impact on PV module.
- 16) When installing modules on roof mounted structures, please try to follow the “from top to bottom” and/or “from left to right” principle, and don’t step on the module. This will damage the module and would be dangerous for personal safety.
- 17) The mechanical loads described in this manual are the test loads. For calculating the equivalent maximum design loads, a safety factor of 1.5 (Test loads=Design loads×1.5 security coefficient) needs to be considered in compliance with the requirements of the local laws and regulations. The design loads are strongly related to the construction, applied standards, location, and local climate conditions; therefore, must be determined by the racking suppliers and/or the professional engineers. For detailed information, please follow local structural code or contact your professional structural engineer. The mechanical load bearing is dependent upon the mounting methods used and failure to follow the instructions of this manual may result in different capabilities to withstand snow and wind loads.
- 18) We recommend that you insure your solar system against natural hazards (e.g., against lightning strikes).

5.2. ENVIRONMENT CONDITIONS AND SITE SELECTION

Topco Solar module should be installed in the following environmental conditions.

Table 5-1 operation condition

NO	Environmental conditions	Range
1	Recommended Working temperature	-20 °C ~ +50 °C
2	Extreme Working temperature	-40 °C ~ +85 °C
3	Storage temperature	-40 °C ~ +50 °C
4	Humidity	< 85RH%

Installation Manual

Remarks: The working environment temperature is the monthly average maximum temperature and minimum temperature of the installation site. The mechanical load bearing capacity of the solar PV modules determined based on the installation method. The professional solar PV system installer must be responsible for calculating the solar PV system machinery when designing the solar PV system load bearing capacity.

If you are planning to use the PV modules where the water damage (Humidity: >85RH%) may be possible, please consult with Topco Solar technical support firstly to determine an appropriate installation method, or to determine whether the installation is possible.

The modules are certified according to the norm IEC 61215 and others for safe operation in moderate climates. The operator needs to consider the effect of the high altitude on the operation of the module, when the modules are installed at high altitude. The maximum altitude allowed for PV Module installation is 2000m.

For most places, PV modules should be installed where the sunlight can be maximally acquired throughout the year. In the Northern Hemisphere, the PV modules should typically face south, and in the Southern Hemisphere, the PV modules should typically face north.



When selecting the installation location, avoid areas with trees, buildings, or obstacles because these objects will form shadows on solar PV modules, especially when the sun is at the lowest position on the horizon in winter. The shadow will cause the loss of the output power of the solar photovoltaic system. Although the bypass diode installed in the PV module can reduce this loss to some extent, do not ignore the shadow factor.

Do not install solar PV modules near fire or flammable materials. Do not install solar PV modules where there is water soaking, sprinkler or water spray.





Position the modules to minimize the chances of shading at all times of the day. Try to install modules in a location where there is rare shading throughout the year.

According to IEC 61701, salt mist corrosion testing of photovoltaic (PV), Topco Solar PV modules can be installed in corrosive salt areas within proximity of the ocean or sulfurous areas. The module must not be soaked in the water or in the environment (i.e., fountain, spindrift, etc.) where the module would touch water (pure water or brine) for a long term. If the modules are placed in an environment of salt fog (i.e., marine environment) or sulfur (i.e., sulfur sources, volcanoes, etc.), there is a risk of corrosion. It's not recommended to install the modules, when the distance is less than 100m ; and it's recommended to install the modules with the anti-salt function, when the distance is between 100m and 1km. So stainless steel or aluminum materials must be used to contact the PV modules, and the installation position must be processed with anti-corrosion treatment. When modules are installed on land less than 1km away from the sea or in an area where the annual rainfall hours / total annual hours exceed 25%, the connectors are recommended to install waterproof cold shrinkable tubes to prevent the connector from water inlet and corrosion; Silicone rubber is recommended for the material of cold shrinkable tube.

Table 5-2 Photovoltaic module connector accessories

Procedure	Method	Explanatory Chart
①	After unplugging the photovoltaic connector, take either end and cover the cold shrinkable tube to the connector in the direction shown on the right.	
②	Slide the cold shrinkable tube over the head of the connecting head and expose the head.	

Installation Manual

<p>③</p>	<p>Connect the positive and negative connectors in the correct way.</p>	
<p>④</p>	<p>Move the connection to the middle of the cold shrinkable tube.</p>	
<p>⑤</p>	<p>Pull the inner ring exposed in the cold shrinkable tube by hand, rotate and pull it out again and again until the inner ring is completely pulled out.</p>	
<p>⑥</p>	<p>The cold shrinkable tube has completely cold shrinkable seal connectors.</p>	

• Notes for installation of cold shrinkable pipe

- ① Before installation, make sure that there is no sand, water, sharp objects and other sundries inside the cold shrinkable tube;
- ② It is forbidden to tie the label on the shrink tube to prevent the tie from scratching the shrink;
- ③ Pay attention to environmental protection on site (handling of support strips/instructions/packaging bags);
- ④ There are no cracks or gaps at both ends of the cold shrinkable tube and no cracks on the surface;
- ⑤ The cold shrinkable tube should be affixed to the connector and cable in a natural way, and no wrinkle or bulge is allowed;

According to IEC62716 “Ammonia corrosion testing of photovoltaic (PV) modules”, Topco Solar modules can be safely installed in ammonia-heavy environments, such as farm, meadow and so on. IEC62716.

According to the surrounding environment of the project, use the appropriate protective measures to ensure the safety of the module installation and reliable. For example, it needs to have around the windproof measures like design of windbreaks in strong wind area.

The system design needs to have the lightning protection function, it must pay more attention especially in the installation ground where are more lightning strike.

When installing PV modules on a roof, the roof must be covered with a layer of fireproof material applicable to this class, and adequate ventilation must be ensured between the back of the module and the installation surface. A safe working area also must be left between the edge of the roof and the external edge of the solar array.

In the case of residential installations on the ground, modules must be installed following local regulations, e.g. using fence.

Installation Manual

5.3. TILT ANGLE OF INSTALLATION

The installation of PV module string should be in the same orientation and the same installation angle. Different installation directions and installation angles will lead to the mismatches in current and voltage which is caused by different light absorption of different PV modules, this mismatch will cause the PV system power output loss.

The largest power will be generated When direct sunlight on solar PV module. For modules which are installed on the fixed brackets, the best installation angle should be selected to ensure the maximum power output can be generated at winter time, if the angle can guarantee enough power output during the winter, it will make the whole solar PV system in the rest of the year can have enough power output also.

Solar modules are recommended to be installed at an optimized tilt angle to maximize the energy output. For detailed information on the best installation angle, please refer to standard solar photovoltaic installation guides or consult a reputable solar installer or systems integrator. Dust building up on the surface of the modules can impair module performance. Topco Solar recommends installing the modules with a tilt angle of at least 10°, making it easier for dust to be washed off by rain. Any faults caused by and/or attributable to tilt angle less than 10 degrees are not covered by manufacturer's warranty. It is roughly equal to the latitude of the project site as a rule of thumb, facing toward the equator. Optimized system designs must incorporate other local requirements.

Installation inclination refers to the Angle between the module and the ground plane, as shown in Figure 5-1.

Fig. 5-1 Tilt angle

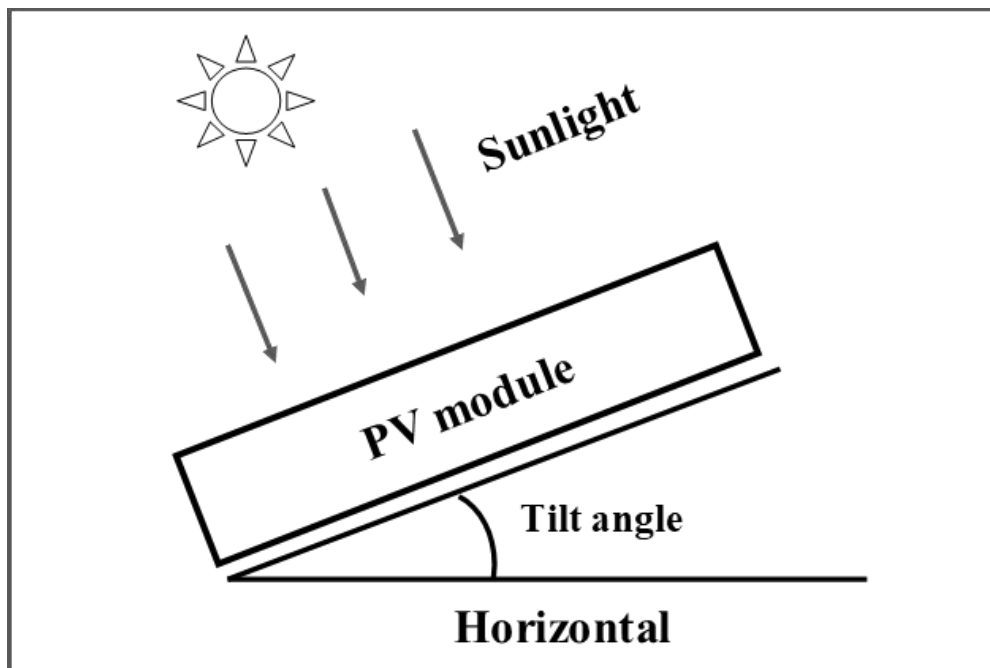

Table 5-3 Recommended tilt angle for fixed systems

Latitude	Tilt angle
0°~15°	15°
15°~25°	The same latitude
25°~30°	Same latitude +5°

30°~35°	Same latitude +10°
35°~40°	Same latitude +15°
40°+	Same latitude +20°

5.4. INSTALLATION REQUIREMENTS FOR BIFACIAL CELLS MODULE

Under the certain installation conditions, the backside of bifacial cells module will also generate electricity power after receiving the reflected light, which will bring additional power generation gain to the power station system.

The shading on the module surface will affect the power generation much, the module should be installed in the place where the module cannot be shadowed totally (such as the shadow from building, chimney and tree etc.), and even the partially shading (such as the dirt, snow and aerial wire etc.) should be avoided.

The generation gain is related to the ground reflectivity, the module installation height to the ground, the arrays spacing and the shadow shading to the module backside.

Generally speaking, the reflectance is various with the different ground (See table 5-4), and this will lead to different power generation gain.

Table 5-4 reflectivity of different surfaces

The ground type	Water	Grassland	Ground	Concrete	Sand	Snow
Reflectivity range (%)	5-12	12-25	20-33	20-40	20-40	80-85

Due to the different ground clearance height will affect the power generation gain, it is recommended to install the module at a height from 1m to 2m. See Fig. 5-2.

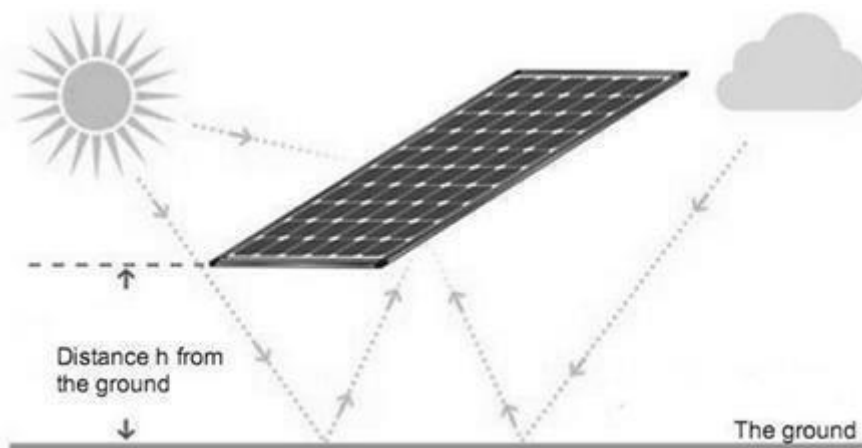

Fig. 5-2 Distance from the earth

In the system design, besides the ground type and the module installation height to ground, the proper array spacing and how to avoid shadow shading on the back need to be considered too, please consult with the professional system designer.

5.5. INSTALLATION METHOD

5.5.1. MECHANICAL INSTALLATION AND WARNING

PV modules can be installed through bolt method and clamp method. The modules must be installed according to the following examples and recommendations. If a different installation method is desired, please contact Topco Solar customer service or technical support team for consultation. Improperly mounted modules maybe damaged. If alternative mounting method is used that has not been approved by Topco Solar, the modules will not continue to carry a valid warranty.

Modules shall not be subjected to wind or snow loads which is exceeding the maximum permissible designedloads, and shall not be subjected to excessive forces due to the thermal expansion of the support structures. The selection and design of mounting bracket shall be carried out by professional system engineers after the load calculation according to the climatic conditions of the installation site. Ensure the installation method and supporting system of modules is strong enough to withstand all the load conditions. The Installer must provide thisguarantee. The installation supporting system must be tested by the third-party organization with the analysis ability of Static Mechanical, according to the local national or international standards.

The modules shall be mounted on continuous rails that extend beneath the modules. If modules are mountedwithout continuous rails, the maximum allowable load will be reduced , which needs to be re-evaluated by Topco Solar.

Please ensure that the modules with the same color cells to be installed together.

A clearance of at least 115mm (recommended) is provided between modules and the surface of the wall or roof.

The minimum clearance between two adjacent single cell modules must not be less than 10mm. The minimum clearance between two adjacent bifacial cell modules must not be less than 20mm. The proper gap can protect against jarring during the neighbouring modules due to the size tolerance or expansion and contraction of modules it also can reduce the wind pressure on the square array. If there are special requirements, please confirm with Topco Solar and install it.

The module frame drain holes cannot be blocked in any situation during installation or use.

Always keep the back of the PV module from coming into contact with foreign bodies or support components,which may damage the module when it is subjected to mechanical load.

The module frames will warp at low temperature. Avoid the frame receiving the lateral tension and pressure, causing the frame off or crushing the glass.

The mounting method must not result in the direct contact of dissimilar metals with the aluminum frame of theModule as it will result in galvanic corrosion. IEC 60950-1 standard recommends metal combinations not exceed an electrochemical potential difference of 0.6V.

To maximize mounting longevity, Topco Solar strongly recommends the use of corrosion proof (stainless steel) attachment hardware.

Secure the module in each mounting location with an M8 bolt (full thread recommended)and a flat washer, spring washer and nut and tighten to a torque of 16~20 N.m. The yield strength of bolt and nut should not be less than 450 MPa. The tightening step is as follows:

- a. Use torque wrench to tighten nut to target torque: 16~20N.m;
- b. Nut loosen 90~180 degrees;
- c. Finally tighten the nut to the target torque and reduce the torque attenuation.

All parts in contact with the modules should use flat stainless steel washers of minimum 1.5mm thicknesswith an outer diameter of 16-20mm. (Except for Single-axis tracking system)

The installation method listed below are for your reference only, the PV system installer or the trained professionals should take the responsibility of the PV system design, mechanical load calculation, install, maintenance and safety, Topco

Installation Manual

Solar will not supply the related material for system installation.

Tools: screwdriver, wrench, stainless steel screw/bolt, clamp, nut and spring washer, plain washer.

A. Mounting with Bolts 4-φ9*14mm mounting holes

Modules can be attached using the mounting holes 4-φ9*14mm on the back of the module frame, by fixing the module to the support rails with bolts. The mounting details are shown in the following figures.

The frame of each module has 8-φ9*14mm mounting holes, ideally placed to optimize the load handling capability, to secure the modules to the supporting structure. The middle four mounting holes are used for normal installation, as shown in Figure 5-3. It is recommended that you put the PV module vertically when you use the bolt to fix it, so that the module will not slide easily and use more safely.

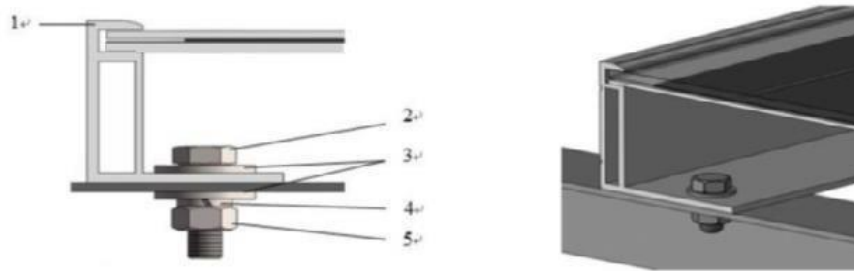
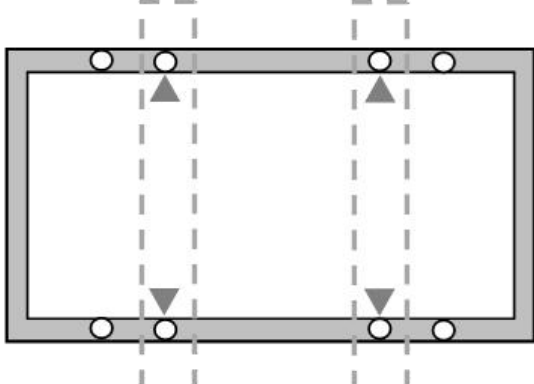

Fig.5-3 Single-glass module with frame

1.aluminum frame; 2.M8 hex bolt M8; 3.flat stainless washer; 4.spring stainless washer ; 5.hex stainless nut

Module	Test Load	Mounting Direction
Length≤2300mm	Uplift load ≤2400Pa Downforce load ≤5400Pa	
2300<Length≤2400mm	Uplift load ≤2400Pa Downforce load ≤3600Pa	<p>*NOTE:</p> <ol style="list-style-type: none"> 1. The crossbeam is perpendicular to the long side frame. 2. Need two support rails below the PV module to make sure the Mechanical load. 3. The load is an empirical value of a standard module based on a standard installation mode, and the specific information shall be consulted by Topco Solar.

Installation Manual

B. Mounting with Clamps

Topco Solar has tested its modules with a number of clamps from different manufacturers, it is recommended to use fixing bolt of at least M8. It is recommended to use a clamp with length of $\geq 60\text{mm}$ and thickness of $\geq 4\text{mm}$, aluminum alloy 6005-T6. The clamp shall not be malfunctioned due to deformation or corrosion during the loading process. If the customer needs a different size of clamps, it should be fully evaluated and approved by Topco Solar.

The clamp must overlap the module frame by at least 7mm but no more than 10mm. Use at least 4 clamps to attach modules to the mounting rails.

Modules clamps should not come into contact with the front glass and must not deform the frame.

The clamps shall not to be out the edge of the module under any circumstances. Be sure to avoid shadowing effects on the solar cells from the module clamps.

The module frame is not to be modified under any circumstances.

When choosing this type of clamp-mounting method, use at least four clamps on each module, two clamps should be attached on each long sides of the module (for portrait orientation) Depending on local wind and snow loads, additional clamps may be required to ensure that modules can bear the load.

Applied torque should refer to mechanical design standard according to the bolt customer is using, ex: M8 16-20N.m.

Clamp positions are of crucial importance for the reliability of the installation. The clamp centerlines must only be positioned within the ranges indicated in table below, depending on the configurations and loads.

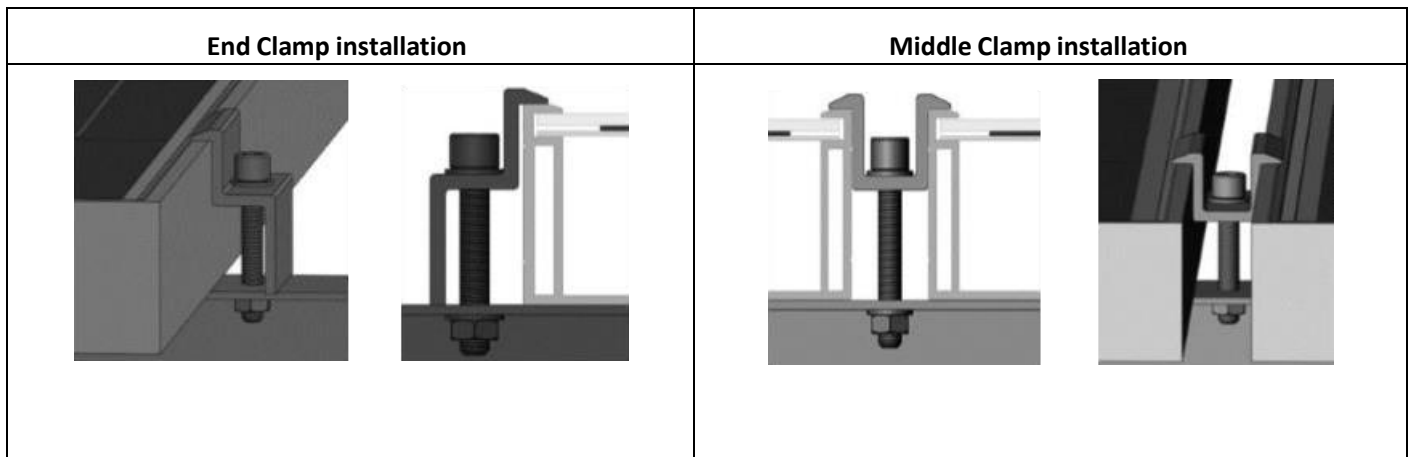

Module	Test Load	Mounting Direction
<p>Length $\leq 2300\text{mm}$</p>	<p>Uplift load $\leq 2400\text{Pa}$ Downforce load $\leq 5400\text{Pa}$</p>	

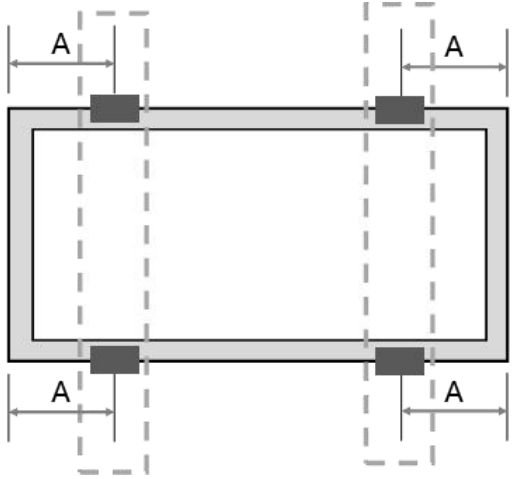
<p>2300 < Length ≤ 2400mm</p>	<p>Uplift load ≤ 2400Pa Downforce load ≤ 3600Pa</p>	 <p style="text-align: center;">$1/6L \leq A \leq 1/4L$; L=Module length</p> <p>*NOTE:</p> <ol style="list-style-type: none"> 1. The crossbeam is perpendicular to the long side frame. 2. The above-described distance is from the module edgeto the middle of the clamp. Clamps length ≥ 60mm. 3. Need two support rails below the PV module to makesure the Mechanical load. 4. The load is an empirical value of a standard module based on a standard installation mode, and the specific information shall be consulted by Topco Solar.
----------------------------------	---	---

***NOTES:**

Topco Solar does not recommend short side installation. When the short side is installed, the support point of the module is far away. Under the weight of the module or the action of a small load, there will be a slight deformation in the middle of the module, which is elastic deformation. After the module is removed or the load is removed, it can be restored to its original state without causing the battery crack and power attenuation , However, it is easy to increase the amount of ash, which requires frequent cleaning of the surface of modules.

In severe environment such as snowstorm, when the modules are subjected to heavy snow load, the central part will produce large shape variables, which will affect the appearance of the modules 。 In the process of module deformation, if the junction box or glass is in contact with the obstacles below, the glass on the back will produce a large stress, and the module will have the risk of rupture. The distance between the obstacles below the module and the junction box or glass is required to be more than 120mm by day rise.

When installing with short side pressing block, load calculation and support structure design shall be carried out by professional structural engineers according to the project climate conditions, and foreign bodies under the positive projection of the module glass shall be avoided. The appearance caused by dead weight or other loads shall not be considered as defects and shall not be within the scope of warranty.

Other mounting configurations can be used. However, failure to comply with the above recommendations will result in a lowering of the load handling capabilities below the empirical value, and product failure as a result of an overload situation will not be covered by the Topco Solar warranty.

Installation Manual

5.5.2. ELECTRICAL INSTALLATION

1. Cable layout

The recommended vertical installation connection methods for module with split J-Box are as follows (The extension cable is required).

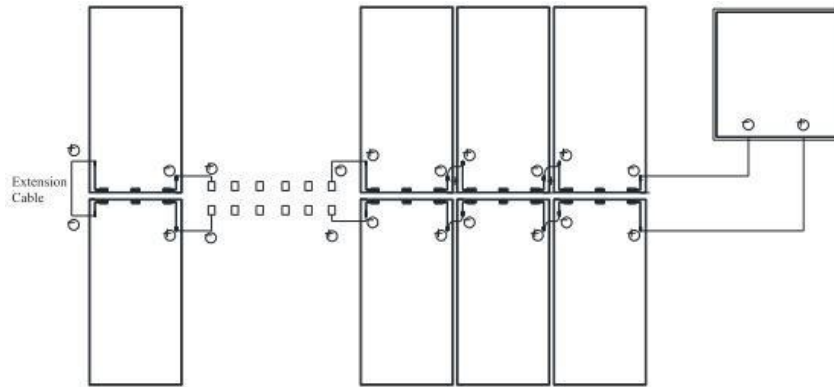

Fig. 5-4 Split J-Box at module side position for vertical direction

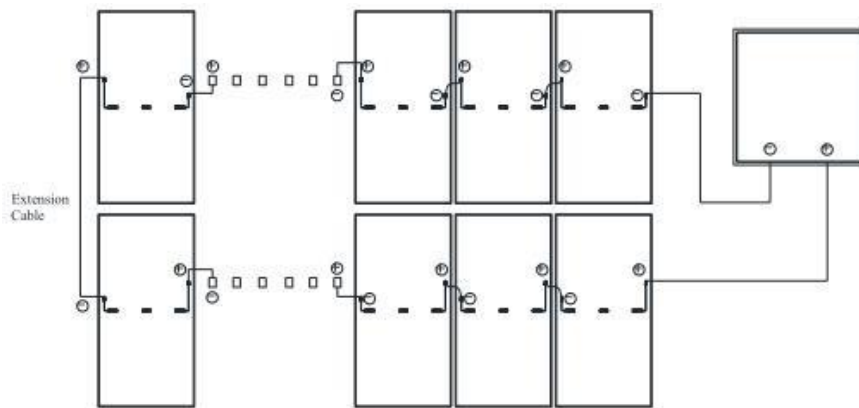

Fig. 5-5 Split J-Box at module middle position for vertical direction

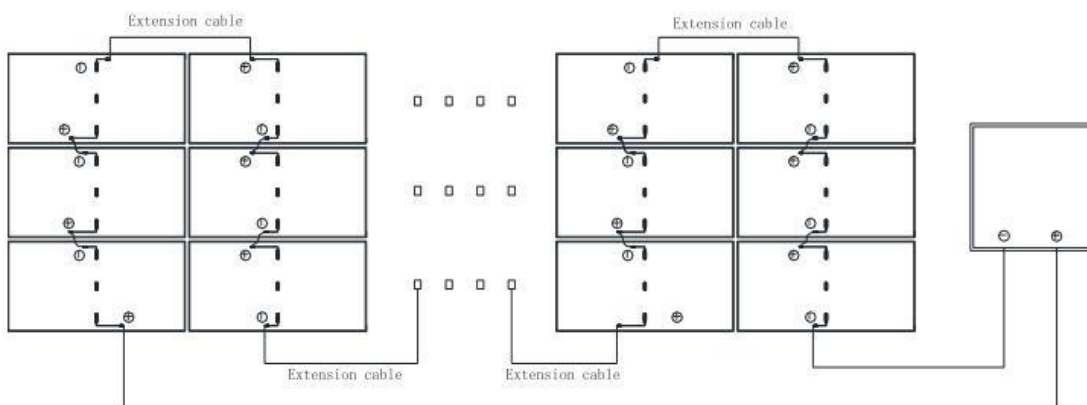

Fig. 5-6 Split J-Box at module middle position for horizontal direction

Precautions: To minimize risk in the event of an indirect lightning strike, avoid forming loops when designing the system. In order to avoid bad or damaged connection of the cable and connector, the cable and junction box caused by human factors, affecting the electrical safety or service life of the product, it is recommended that the force applied between the cable and

Installation Manual

connector, cable and junction box shall not be greater than 60N during the installation, dismantling, maintenance and any other related process of the Product.

Pay attention to the direction of the wire when installing the modules. It should be connected along the wire direction to avoid bending the wire.

2. Electrical Connection

The Direct Current (DC) generated by the PV system can be converted to Alternating Current (AC) and connected to the public power grid. Different regions may have different policies, laws and regulations to stipulate the installation and grid-connection requirements of PV systems. Therefore, during the design, installation, and grid-connection of PV system, please comply with the local policies, laws and regulations.

PV modules can obtain different current and voltage outputs through series connection and parallel connection. Read this installation manual carefully before electrical connection and installation. Please design and connect according to the current and voltage required by customers. Before connection, please ensure that the connection part is free from corrosion, and keep it clean and dry.

Different types of modules cannot be connected in series. Modules connected in series should ensure the consistency of their current (For the rest of modules with different current classes, the modules with adjacent current class can be installed in one given string.). The voltage of the module string should not exceed the allowable system voltage value, which can be found on the nameplate or datasheet of the module.

The standard copper cables applied in Topco Solar modules are UV resistant and with a cross-sectional area of $\geq 4 \text{ mm}^2$ (12 AWG). All other cables used to connect the DC system should have a similar (or better) specification.

The maximum number of modules in series depends on the system design, the type of converter used and the environmental conditions. In general, the maximum number (N) of PV modules in series can be calculated by dividing the maximum system voltage by the open circuit voltage of the relevant solar PV modules. When designing the solar PV system, it is necessary to take into account the characteristic that the voltage of the solar PV module changes with the temperature. Considering the voltage increase caused by temperature drop in extreme environment in winter, the maximum series connection number of solar PV modules can be calculated by the following formula.

Table 5-5 maximum series connection number calculation

Formula 公式	Maximum system voltage $V \geq N * V_{oc} * [1 + \beta * (T_{min} - 25)]$
V	Maximum system voltage
N	The number of maximum solar PV modules in series
V_{oc}	The open circuit voltage of each module (see product label or datasheet)
β	Temperature coefficient of open circuit voltage of the module (refer to datasheet)
T_{min}	The lowest ambient temperature at installation site

The number of modules that can be connected shall be determined by a qualified institution or person in accordance with the design specifications of the photovoltaic system and the local electrical design specifications. The calculation formula recommended by Topco Solar shall be for reference only.

If the modules are allowed to be installed in parallel electrically, each module (or series string of modules so connected) shall be provided with the maximum series fuse as specified. For applications requiring high currents, several photovoltaic modules can be connected in parallel; the total current is equal to the sum of individual currents, each module (or series string of modules so connected) shall be provided with the maximum series fuse as specified. The recommended number of modules in parallel is only one. The modules' electrical performance in a system is the same. When connected in series, all

Installation Manual

modules must have the same amperage. When connected in parallel, the modules must all have the same voltage. Connect the quantity of modules that match the voltage specifications of the devices used in the system. The modules must not be connected together to create a voltage that is higher than the permitted system voltage.

Product can be irreparably damaged if an array string is connected in reverse polarity to another. Always verify the voltage and polarity of each individual string before making a parallel connection. If you measure a reversed polarity or a difference of more than 10V between strings then check the string configuration before making the connection.

Before wiring the module, ensure that the contact points are corrosion resistant, clean, and dry; If a string of modules is reversed, irreparable damage can be caused.

During field wiring, only single-wire photovoltaic special copper cables with minimum temperature resistance of 90 °C , sunlight resistance (UV) and cross-sectional area of no less than 4mm² can be used as photovoltaic connecting wires. The minimum and maximum outer diameters of the cable are 5 to 7mm. The minimum bending radius of the cables must be 43mm. Any cable damage caused by bending too much or cable management system is not covered under Topco Solar's warranty. When installing modules on the roof, it is recommended to use 4~6mm² special photovoltaic cable. Plug & Play connectors are included at the end of each cable. All other cables used to connect the direct current system shall have similar (or higher) specifications, and should have the suitable insulation ability which can suffer the possible maximum system V_{oc} (as defined in TUV 2PFG1169 or EN50618 (H1Z2Z2-K)) or 62930 IEC 131 1x4mm². Topco Solar requires all cables and electrical connections to comply with the electrical regulations of the countries where the PV system is installed.

Under normal conditions, a PV module is likely to experience conditions that produce higher current and/or voltage than reported at standard test conditions. Accordingly, the values of I_{sc} and V_{oc} . marked on this PV module should be multiplied by a factor of 1.25 at least when determining component voltage ratings, conductor current ratings, and size of controls (e.g. inverter) connected to the PV output.

When selecting a cable, the minimum current-carrying capacity of the cable can be calculated by the following formula.

Minimum current-carrying capacity of the cable = 1.25 * I_{sc} * N_p I_{sc}:

short-circuit current of PV module (unit: A)

N_p: the number of modules in parallel or module strings

To ensure proper system operation the correct cable connection polarity should be observed when connecting the modules to each other or to a load, such as inverter, a battery etc. If modules were not connected correctly, the bypass diodes could be destroyed.

Before connecting the module, please make sure using the connector approved by Topco Solar. Otherwise, Topco Solar does not responsible for any potential defects or risks. When conducting electrical connection of the modules, please use diagonal pliers to cut the cable tie. When cutting the tie, be careful not to scratch the cables or the backside of the module. According to the electrical requirements. The positive and negative connectors should be connected in turn, and confirm that you hear a "click" to indicate that the connection is successful. Otherwise, during the operation of the modules, this could lead to electric arc due to poor connections and can burn the connectors. It is not recommended to interconnect different types of connectors. Please pay attention that the unlock method of connectors is different according to local laws and regulations.

When modules are in series connection, the string voltage is sum of every individual module in one string. When modules are in parallel connection, the current is sum of the individual module as shown in below figure 5-7. Modules with different electric performance models cannot be connected in one string. During there is no any protection for string due to suitable anti-reverse devices and fuse, do not connect two or more strings with Y or T connector. Do not connect fuse in Combiner Box or string inverter with two or more strings in parallel connection without any anti- reverse devices or function.

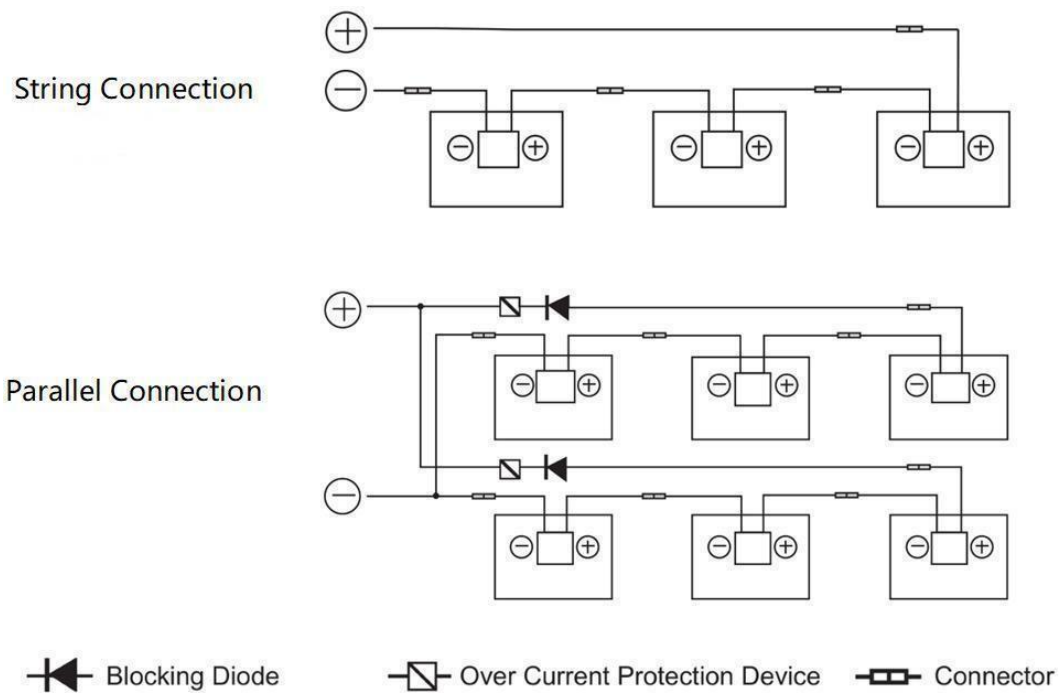

Fig. 5-7 Series Connection and Parallel Connection Circuit Diagram

Before the commissioning and operation of the power station, please check the electrical connection of modules and strings, making sure all connection polarity is correct and the open circuit voltage meets the requirements of the acceptance criteria.

The number of modules in series and in parallel shall be designed reasonably according to the system configuration.

To clear or trim excess cables and Topco Solar recommends that all cables be away from standing water and placed in proper pipework for avoiding the accelerated aging due to UV irradiation.

Topco Solar recommends using lightning protection devices which are complied with local laws and electrical regulations. All the above instructions must be followed to meet Topco Solar warranty conditions.

3. Bypass secondary

If PV module part by shadow block, which can lead to reverse voltage related to solar cells, PV modules in other unaffected battery string or other PV modules in the system and current will force through keep out part of the power loss and heat affected cell. When the PV module is connected in parallel with the bypass diode, the current in the system will flow directly through the diode, so as to bypass the blocked part of the PV module and minimize the heating degree and power consumption of the PV module. Bypass diodes are not over-current protective devices.

Each module has three diodes. Please do not try to open the junction box to replace the diode, or even when the diode problem, please do this work by professionals.

Please pay attention to guard against inductive lighting, backflow, and wrong connection.

4. Grounding

All module frames and mounting racks must be properly grounded in accordance with the electrical design and construction specifications, procedures, regulations, and other special grounding requirements applicable to the installation sites.

Proper grounding can be achieved by connecting the module frame(s) and all metallic structural components together

Installation Manual

by using a suitable grounding conductor. The grounding conductors or wires may be copper, alloy, or any other materials that are in accordance with the local electrical design and construction specifications, procedures, and regulations. It is recommended to use the copper wire (4-14mm² or AWG 6-12) as the grounding wire. The symbol "⏏" can be found at the grounding hole position. The ground wire must also be connected to ground through a suitable ground electrode. The tight connection of all the joint point should be ensured.

On a grounding hole with a diameter of $\phi 4$ mm, use a separate grounding wire and related accessories to connect the aluminum frame of the solar PV module and connect the grounding wire to the ground. The grounding uses the M4*12mm bolts and M4 nuts, star washers and plain washers, this ensures that the modules are firmly grounded. You can find the corresponding product drawing in module datasheet to know the detailed number, size and position of the grounding holes. The torque applied to ground fixation is 4N·m~8N·m. Do not drill any extra ground holes for convenience, this will void the modules warranty. Topco Solar recommends using grounding wires with resistances that are less than 1 Ω .

If Grounding of Module through mounting holes by using serrated washers or nuts without any additional requirement of grounding arrangement, then the ground resistance of the whole racking system shall be kept to be less than 4 Ω . For this, new serrated washers shall be used and in any re-use of used washers will not be allowed

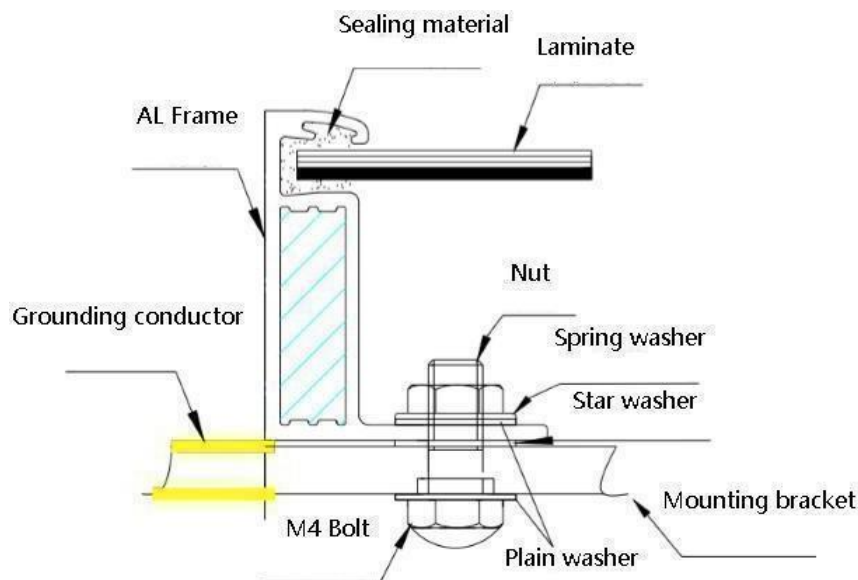

Fig. 5-8 Grounding Diagram

When grounding, each module can be grounded directly or in series or in parallel. If you choose the latter two options, it is recommended that the maximum number of modules connected in parallel should not exceed four, and in series should not exceed eight.

In addition to use the grounding hole, you can also choose the following grounding ways:

- 1) Grounding by unused mounting holes
- 2) Other professional grounding devices

The electrical contact points of all the above grounding methods should penetrate the anodized film of the aluminum frame. PV modules can be grounded by other grounding devices, which must be reliable and certified. The manufacturer's requirements should be followed.

6. MODULE MAINTENANCE

In order to ensure the long-term using of the installed PV system and maximize the Power output performance of the modules, the installed PV modules need to be inspected and maintained regularly, which is the responsibility of the users.

Installation Manual

The inspection and maintenance of modules in the PV array shall be carried out by personnel who have received professional PV system maintenance training and obtained relevant qualifications and authorization.

6.1. PANEL VISUAL INSPECTION AND REPLACEMENT

The modules in a PV array should be regularly checked for damage. Factors such as glass breakage, cable breakage, junction box damage and the terminals cannot be connected well may lead to function and safety problems. In the case of a damaged module, replace it with the same type of module. Do not touch live parts of cables and connectors. Use appropriate safety equipment (insulated tools, insulating gloves, etc.) when handling modules. Refer to the appropriate Product Installation Manual for installation and disassembly of module.

Check the electrical, grounding and mechanical connections once at least during every 6 months to ensure they are clean and safe, free from damage or rust. Check that all string fuses in each non/earthed pole are operating. Check that the mounting parts are tight. Check all cables and make sure that the connectors are securely. PV modules frames and bracket should be well mechanically connected.

Check whether there is any foreign body on the surface of the PV modules and whether there is any shielding.

The vegetation should be cut regularly to avoid shading and thus affecting the module's performance.

When repairing PV modules, cover the surface of PV modules with opaque material to prevent electric shock. Exposure of PV modules to sunlight will generate high voltages, this is dangerous. Please pay attention to safety when maintenance and it must be done by professionals.

Wear cut resistant gloves and other personal protective equipment required for the particular installation. Isolate the impacted array string to prevent current flow before attempting to remove the module. Disconnect the connectors of the affected module using the related disconnect tool provided by suppliers. Replace the damaged module with a new functional module of the same type.

In a system using a battery, blocking diodes are typically placed between the battery and the PV module output to prevent battery discharge at night.

When the irradiance is no less than $200\text{W}/\text{m}^2$, if the terminal voltage is more than 5% different than the rated value, it illustrates the connection of the modules is not good.

Comply with maintenance instructions for all modules used in the PV system, such as brackets, charging rectifiers, inverters, batteries, lightning protection systems, etc.

Warning: The warning signs on the PV modules must not be lost. Any electrical maintenance must shut down the PV system firstly. Improper system maintenance may cause fatal dangers such as electric shock and burning. Observe the safety precautions listed earlier in this Manual.

6.2. CONNECTOR AND CABLE INSPECTION

It's recommended to implement the following preventive maintenance every 6 months:

- 1) Check the sealing gels of the junction box for any damage.
- 2) Examine the PV module(s) for signs of deterioration. Check all wiring for possible rodent damage, weathering and that all connections are tight and corrosion free. Check electrical leakage to ground.
- 3) Inspect all cables to verify that connections are tight, the cables are protected from direct sunlight and sited away from areas of water collection.
- 4) Check the torque of terminal bolts and the general condition of wiring. Also, check that mounting hardware is properly torqued. Loose connections will result in damage to the array.

6.3. CLEANING

This manual covers the requirements for the cleaning procedures of Topco Solar PV modules. Professional installers should read these guidelines carefully and strictly follow these instructions. Failure to follow these instructions may result in death, injury, or property damage. Damages induced by inappropriate cleaning procedures will void Topco Solar warranty.

The power output of the module is related to the received sunlight. Dust accumulation on the glass surface of the module will reduce its power output and may even cause hot spots. So the surface of PV modules should be kept clean. Maintenance work should be performed at least once six months or frequently. The dirt such as bird droppings, leaves, dust is usually need to be cleaned.

Warning: It should be carried out by trained personnel. Workers should wear PPE, such as goggles, electric insulation gloves and safety shoes. The gloves should withstand DC voltages of no less than 2000V.

Improper cleaning activities create risk of damaging the modules and array components, as well as increasing the potential electric shock hazard. Cracked or broken modules represent an electric shock hazard due to leakage currents, and the risk of shock is increased when modules are wet. Before cleaning, thoroughly inspect modules for cracks, damage, and loose connections.

During the daylight, the voltage and current present in the array are sufficient to cause a fatal electric shock. Clean PV modules when the irradiance is below 200W/m². Before cleaning, please make sure that the circuit is disconnected, otherwise contact with the exposed part of live parts will cause injury. Wear suitable protective clothing (clothes, insulating gloves, etc.) when cleaning the modules. Do not immerse the module, partially or totally, in water or any other cleaning solutions. Do not use such as lubricants and organic solvents to clean the connectors.

Use a dry or wet, soft and clean cleaning cloth, sponge, or soft bristled brush to gently wipe the modules. Please make sure that the cleaning tools do not wear out glass, EPDM, silicon, aluminum alloys or steel. Do not use corrosive solvents and do not wipe the PV modules with hard objects. The module must not be subjected to additional external force. If there is greasy dirt and other substances on the surface of the PV module which are difficult to clean, conventional household glass cleaning agents can be used. Do not use the alkaline and strong acid solvents, including hydrofluoric acid, alkali, acetone. If necessary, use iso-Propyl alcohol (IPA) or other solution according to the safety instructions to clean and ensure that no solution flows into the gap between the edge of the module and the module frame.

When cleaning the modules, use a soft cloth together with a mild detergent and clean water. Take care to avoid severe thermal shocks which might damage the module by cleaning modules with water which make sure the temperature difference between the water and the module is in the range of -5°C ~ 10°C. For example, do not use cold water to clean the module when the temperature of it is high during the day, otherwise there will be the risk of module damage.

It is forbidden to clean PV modules under the weather conditions of wind more than 4 grades (in Beaufort scale), heavy rain or heavy snow.

When cleaning PV modules, do not step on the modules; Do not spray water on the backside of the module or the cables; keep the connectors clean and dry; prevent fire and electrical shock from occurring; Do not use steam cleaner.

The back surface of the module normally does not need to be cleaned but, in the event this is deemed necessary, avoid the use of any sharp projects that might damage the penetrating the substrate material. When cleaning the back surface of the module, take care to avoid penetrating the substrate material. The other cleaning requirements are the same as the front-side.

Do not scrape or grind stains off surfaces while PV modules are dry, as this can cause minor scratches on the surface.

CLEANING METHODS

Method A: Compressed water Requirement for water quality:

Installation Manual

- 1) pH: 6~8;
- 2) Chloride or salt content: 0 ~3000 mg/L
- 3) Turbidity: 0~30 NTU
- 4) Conductivity: 1500~3000 $\mu\text{s}/\text{cm}$
- 5) Total dissolved solids (TDS): ≤ 1000 mg/L
- 6) Water hardness (calcium and magnesium ions): 0~40 mg/L
- 7) Recommend to use soft water to wash.
- 8) Water pressure on the glass surface of the module must not exceed 700 KPa.

Method B: Compressed Air

Topco Solar recommends using this method to clean the soft dirt (like dust) on modules. This technique can be applied as long as the method is efficient enough to clean the modules considering the on-site conditions.

Method C: Wet cleaning

If excessive soiling is present on the module surface, a non-conductive brush, sponge, or other mild agitating method may be used with caution.

Please make sure that any cleaning tools are constructed with non-conductive materials to minimize risk of electric shock and that they are not abrasive to the glass or the aluminum frame.

If grease is present, an environmentally friendly cleaning agent may be used with caution. Do not use the alkaline and strong acid solvents. If necessary, use iso-Propyl alcohol (IPA) or other solution according to the safety instructions to clean and ensure that no solution flows into the gap between the edge of the module and the module frame.

Method D: Cleaning robot

If a cleaning robot is used for cleaning, the brush material is required to be soft plastic material with famous brand such as Dupont and the cleaning method is required to be wet cleaning, and the glass surface and aluminum alloy frame of the module will not be scratched during the cleaning process and after cleaning. The weight of the cleaning robot should not be too large. If the cleaning robot is improperly used, and the resulting module damage and power attenuation are not covered by Topco Solar's warranty.

6.3.1. MODULE INSPECTION AFTER CLEANING

- 1) Ensure that the module under visual inspection is clean, bright and free of stains;
- 2) Spot check to verify whether there is soot deposit on the module surface;
- 3) Check to whether there are visible scratches on the surface of the module or not;
- 4) Check whether there is no man-made cracks on the module surface or not;
- 5) Check whether the module support structure is leaning or bent or not;
- 6) Check whether the connectors of the module are detached or not;
- 7) After cleaning, fill out the PV module cleaning record.

6.3.2. TROUBLESHOOTING

If the PV system does not work properly, please inform your installer immediately. It is recommended to perform a preventive inspection at least every six months, please don't change any modules of the modules. If electrical or mechanical properties are required for inspection or maintenance, qualified professionals should be advised to avoid any electric shock or loss of life.