

TOPCO SOLAR



Contents

1 General Information----- 1

 Installation Manual Disclaimer ----- 1

 Limitation of liability ----- 1

2 General Principles Of Security ----- 1

 Electrical safety ----- 2

 Fire Safety ----- 3

 Transportation safety----- 3

 Install Security----- 3

3 Electrical Properties ----- 4

 Electrical installation----- 4

 Cables and wires ----- 5

 Connector ----- 5

 Bypass Diode----- 5

 Grounding ----- 6

4 Handling, transportation, storage and unpacking ----- 7

 Handling, Transportation and Tran-shipment ----- 7

 Storage ----- 8

 Unpacking ----- 9

5 Module Installation----- 11

 Installation environment----- 11

 Inclination Choice----- 11

 Machinery Installation----- 12

 Location Choice ----- 12

 Wiring ----- 13

6 Installation Guide ----- 15

 Installation Method: Bolting ----- 16

 Installation method: Clamps ----- 17

7 Maintenance ----- 21

 Cleaning ----- 21

 Visual inspection ----- 21

 Inspection of connector and cable ----- 21

AMENDED EDITIONS AND DATES----- 22

INTERNAL FILE NUMBER----- 22

1 General Information

This general manual provides important electrical and mechanical installation information. For correctly installation and obtain stable power output, please read and understand this manual carefully before installing and maintaining the PV modules. And keep this manual properly for future reference during PV module maintenance or sales.

This manual does not constitute a warranty, expressed or implied. Topco solar does not assume responsibility and expressly disclaims liability for loss, damage, or expense arising out of or in any way connected with installation, operation, use or maintenance of modules.

PV module should be installed in accordance with all safety precautions in the manual and local laws and regulations, and should be installed and maintained by qualified professionals who have professional skills and knowledge and are familiar with the mechanical and electrical requirements of the system. The installer must inform the customer.

Any questions, please contact with the salesman or customer service personnel of Topco for further explanations.

Installation Manual Disclaimer

Topco Solar reserves the right to change this user manual without prior notice.

This user manual is not a warranty, nor does it have any meaning of warranty.

This manual will be updated from time to time, please contact the commercial department of Topco to obtain relevant products and documents.

Limitation of liability

Topco Solar shall not be responsible for any kind of injury, including but not limited to physical injury or property damage caused by module operation, system installation error or failure to follow instructions in this manual.

2 General Principles of Security

Modules rated for use in this application class may be used in systems operating at greater than 50V DC or 240W, where general contact access is anticipated. Modules qualified for safety through IEC 61730-1 and this part of IEC 61730 within this application class are considered to meet the requirements for safety class II.

No matter whether the PV module is connected to the system or not, proper protective measures should be used when touching the PV module, such as insulation tools, safety caps, insulation gloves, safety belts, and safety insulation shoes. During installing, grounding, connecting cables, and cleaning modules, the proper electrical protection tools must be used too.

Avoid contact with modules directly, which may cause electric shocks or cuts.

The installation should comply with the laws and regulations specified by the relevant region and country. If necessary, obtain the required certificates such as building permit.

Module installation shall be carried out by qualified professionals with technical knowledge and familiarity with the mechanical and electrical requirements of the system. Be aware of the risks of injury, including electric shock, that may occur during installation.

The modules are applied to the ground, roof, fish pond and other outdoor environments. Proper design of support structures is the responsibility of the system designer or installer. When applied to roof installation, the overall fire rating of the final structure needs to be considered, as well as the overall maintenance of the later period. A roof system can only be installed on a roof that has been assessed by a construction expert with the results of a formal complete structural analysis.

Comply with safety regulations for all installed components. Such as wires and cables, connectors, charging controllers, inverters, batteries, etc., only the equipment, connectors, wires, and brackets that match the solar power system can be used. If the photovoltaic system uses energy storage batteries, the configuration of the modules should follow the advice of the battery manufacturer. Only same size modules and specifications can be connected in series.

Meaning of crossed-out wheeled dustbin: Do not dispose of electrical appliances as unsorted municipal waste, use separate collection facilities.

Contact your local government for information regarding the collection systems available.

If electrical appliances are disposed of in landfills or dumps, hazardous substances can leak into the groundwater and get into the food chain, damaging your health and well-being.

When replacing old appliances with new ones, the retailer is legally obligated to take back your old appliance for disposals at least free of charge.



Electrical safety

For avoid any form of electrical accidents, please followed the following electrical safety provisions strictly.

- ❖ Damaged modules pose a risk of electric shock and fire, should be replaced immediately.
- ❖ The DC voltage generated by module may exceed 30V, please avoid contact directly.
- ❖ Ensure that the cable is fixed to the support bracket for installing modules.
- ❖ Protect cables with catheters in areas accessible to animals and children.
- ❖ Do not manually modify or remove any module or
- ❖ The installation of the module array must be carried out in isolation from direct sunlight.
- ❖ The serial voltage of modules must not exceed the maximum system voltage.
- ❖ Do not connect modules with connectors of different models from different manufacturers.
- ❖ Do not replace roofing and wall materials with modules.
- ❖ Do not connect or disconnect modules when

- label.
- ❖ Do not install modules without taking protective measures.
 - ❖ Do not use any means other than connectors for electrical connection.
 - ❖ Do not add any light concentrators to the module.
 - there is current or external current.
 - ❖ Do not coat the surface of the module with corrosive chemicals.
 - ❖ Do not install or operate modules in damp or windy conditions.
 - ❖ Do not touch the module when it is wet.

Fire Safety

Before installing modules on the roof, refer to local laws and regulations and comply with building fire protection requirements. The roof shall be covered with a suitable grade of fireproof material for roof installation and to ensure that the modules and mounting surfaces are fully ventilated. Different roof structures and installation methods can affect the fire performance of a building. Improper installation may cause a fire.

Use appropriate components such as fuses, circuit breakers and ground connectors according to local regulations.

Do not install or use modules near open flames or flammable or explosive objects.

Transportation safety

Do not open the packing case before the modules arrive at the installation site. Place the packing case in a dry and ventilated environment.

During all handling, ensure that the module will not be shaken, dropped to the ground, or objects will fall on the module, as this will damage the module or the solar cells in the module. Do not allow children or unauthorized persons to handle modules. Improper handling and placement may result in glass breakage or loss of electrical properties, thus rendering the modules useless.

Handle and installation modules with care. Under no circumstances should assemblies be lifted by lifting junction boxes or cables. Two or more persons must hold the edges of assemblies with both hands.

Do not step on, stand on or sit on modules as this can damage modules and risk injury to people.

Do not stack modules, do not place any heavy objects on the front and back of modules, and do not place modules on sharp surfaces.

Install Security

Comply with safety rules applicable to all installed modules. Such as wires and cables, connectors, charging controllers, inverters, batteries, etc., only the equipment, connectors, wires, and rails that match the solar power system can be used.

If the photovoltaic system uses energy storage batteries, the configuration of the modules should follow the advice of the battery manufacturer.

Do not install or operate s in damp or windy conditions, and keep the junction box cover closed.

The glass can protect the module, improper operation may cause the glass to be broken. Damaged module poses a risk of electric shock and fire. Such modules cannot be repaired or repaired and should be replaced immediately.

When sunlight strikes the front of the module, the module generates electricity and the DC voltage may exceed 30V. Avoid direct contact with the voltage of 30V or higher to avoid danger.

To reduce or avoid the array mismatch effect, it is recommended to connect modules with similar electrical properties on the same string.

When connecting modules, ensure that the connecting cables are fixed on the support frame of the nodule to limit the swing of the slack part of the cable.

Comply with the minimum bending radius of the cable (not less than 43mm is recommended).

3 Electrical Properties

Electrical installation

The module product specification lists the specific electrical performance of photovoltaic modules in detail, and the nameplate of each module is also marked with the main electrical performance parameters under STC conditions (1000W/m², AM 1.5, cell temperature 25°C). The product specification and nameplate are also marked with the maximum system voltage of the module.

Under certain environmental conditions, the current or voltage generated by the module may be greater than the operating current or voltage for standard test conditions (STC). Therefore, when determining the current/voltage ratings and load values of electrical components, the module short-circuit current under STC should be multiplied by 1.25, and the open-circuit voltage should be corrected according to the calculation formula below:

$$\text{Maximum System Voltage} \geq N \times V_{oc} \times [1 + \lambda_{voc} (T_{min} - 25 \text{ } ^\circ\text{C})]$$

While,

N — Serial number of modules in strings

V_{oc} — Open circuit voltage value of module under STC (see module nameplate)

λ_{voc} — Open circuit voltage temperature coefficient of the module (see module technical specification)

T_{min} — Annual minimum temperature for module installation position (for example, -20 °C, T_{min} = -20)

When determining the appropriate wire and fuse specifications, the maximum fuse current rating is selected by reference to the product specifications.

The system electrical design and calculation shall be determined by a qualified electrical engineer.

The minimum over-current protection device specification is determined by calculating the maximum expected current of the photovoltaic system. The maximum over-current protection device specification is mandatory in IEC 61215:2016 and IEC61730:2016 standards.

If there may be a reverse current through the module that exceeds the maximum fuse current, the module must be protected by over-current protection. If the number of parallel connections is greater than or equal to 2, an over-current guard must be installed on each assembly.

Do not install in rainy weather, moisture will lead to insulation failure, prone to safety accidents.

For specific electrical performance parameters, please refer to the product specifications.

Cables and wires

The modules use junction boxes with protection class IP68 or above, with connected cables and connectors. The junction box of each module is equipped with two separate wires, one positive and one negative, which can be connected in series by inserting the positive connector of one module into the socket of the negative connector of the adjacent module.

During installation, do not use lubricating oil or alkane cleaning agents to clean connectors, junction boxes, and cables.

The cross-sectional area of the cable and the capacity of the connector must meet the maximum short-circuit current of the module (for a single module, the cross-sectional area of the cable is 4mm^2 , and the cable temperature ranges from -40°C to $+90^\circ\text{C}$).

When the cable is fixed on the bracket, it is necessary to avoid mechanical damage to the cable or module. The cable is fixed on the bracket with specially designed light resistant tie and cable card. The cable is light resistant and waterproof, and avoid direct sunlight and water soaking the cable.

Connector

When connecting modules, ensure that the connectors of the same string of modules are from the same manufacturer or fully compatible, and the connection terminals of the modules and the system must also be in the same way. The connectors of different manufacturers may be incompatible, which may cause mismatching and burning.

Keep the connector dry and clean.

Do not connect the connector when it is damp or dirty.

Do not expose the connector to direct sunlight or water.

Bypass Diode

The junction box of the Topco module contains the bypass diode and forms a parallel structure with the circuit. When the solar cells of the module are blocked or damaged, the hot spot phenomenon occurs in the part of the module, the diode will work, so that the current no longer flows through the hot spot solar cell, to limit the heating and performance loss of the module.

Note that the bypass diode is not an over-current protector.

Grounding

The module uses anodized corrosion-resistant aluminum alloy frames as rigid supports. To protect the module from lightning and static electricity, and to protect personal safety. All frames and mounting brackets of the components must be grounded. If there are no specific regulations, please follow the International Electrotechnical Commission standard or other international standards. Connect the ground cable with the recommended connection terminal and fix it to the module frame. It is recommended to use 12AWG copper core wire. Figure 1 shows the grounding hole and its identification on the assembly, and Figure 2 shows the assembly grounding method.

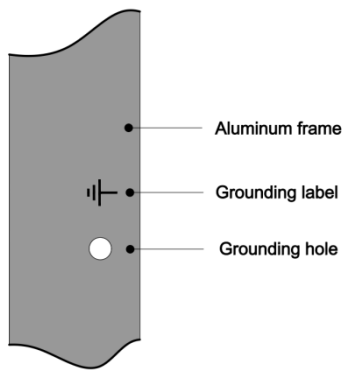

Figure 1. Ground hole and its identification

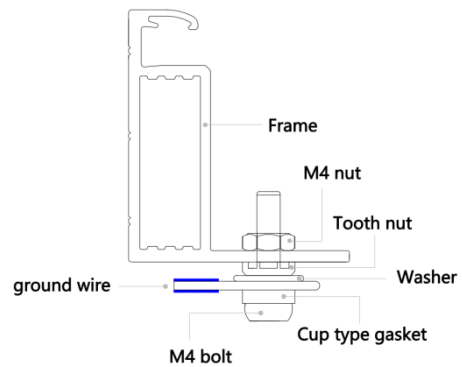

Figure 2. Grounding method

The holes are used for grounding only and cannot be used to install module. Do not drill any additional ground holes on any frame of the modules. Otherwise, the module warranty will be invalid.

When grounding, the grounding device must fully contact the interior of aluminum alloy, penetrate the oxide film on the surface of the frame, and connect the frame of the module and the supporting member to achieve good grounding effect. Use an electroplated support frame to ensure good electrical conductivity.

The ground conductor must be connected to the ground by a suitable ground electrode. You are advised to use a ground cable accessory (wiring nose) to connect the ground cable. Weld the ground cable into the socket of the wiring nose, insert the M4 screw into the ring of the wiring nose and the hole in the middle of the module frame, and secure the cable using a nut. Spring washers should be used to prevent screw loosening resulting in poor grounding.

If the module is used in a high temperature and humidity environment, it is recommended to install an inverter with an isolation transformer that can be negatively grounded (figure 3 shows the system voltage polarity configuration).

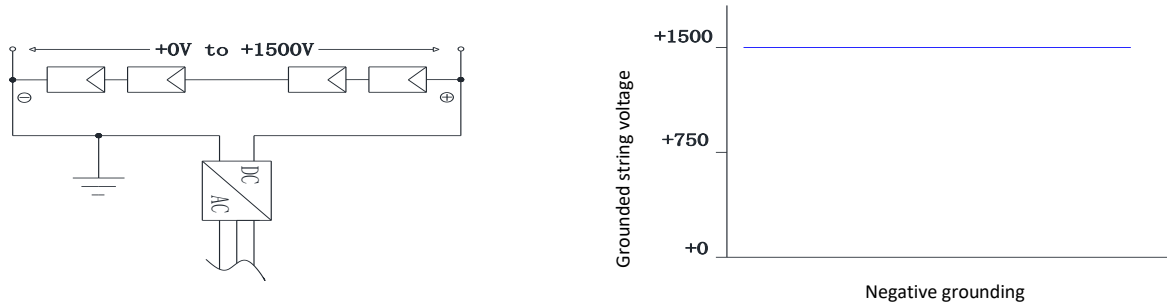

Figure 3. Schematic diagram of grounding potential of inverter

The module may be grounded using a third party grounding device, provided that the grounding device is reliable and proven and operated in accordance with the manufacturer's requirements.

4 Handling, transportation, storage and unpacking

Topco Solar's module has horizontal packaging and vertical packaging according to different product. There are significant differences between horizontal packaging and vertical packaging in loading, unloading, transportation and unpacking. Please be sure to follow the above operations in this manual.

The patterns of horizontal and vertical packaging are as follows:

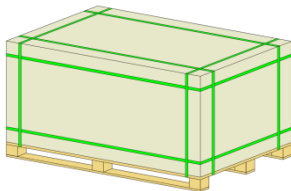

Figure 4. Horizontal packaging

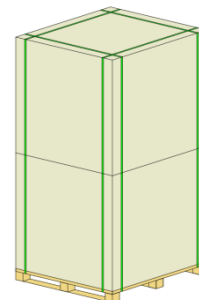

Figure 5. Vertical packaging

Handling, Transportation and Tran-shipment

After the module arrived, please check the overall status of the package in time. If there is any abnormal condition such as package damage, deformation or skew, please contact the customer service or logistics personnel of Topco immediately.

Place the module on flat ground after transporting it to the installation site.

Forklift to unload

If forklift tools are used, the forklift tools should be reasonably selected according to the size and weight of the goods. If the fork of the forklift is less than 3/4 of the size of the cargo, it should be covered with an extended fork assembly to avoid tipping the package when moving the forklift.

Straight-line driving speed control of forklift truck transportation $\leq 5\text{km/h}$, turning speed $\leq 3\text{km/h}$; During

transportation, the spacing between goods and inserts should be adjusted to the maximum position of the spacing between pallets.

During loading and unloading, except forklift operators, other personnel should keep within a safe distance to ensure personnel safety.

Lifting the unloading

If a crane is used to unload the package, use a dedicated hoisting tool. Select a proper hoisting tool based on the weight and size of modules. Use a fixing tool of the same size on the top of the package to prevent the lifting rope from squeezing the package or modules.

Horizontal packaging can lift up to 4 sets of modules at a time, vertical packaging can lift up to 2 sets of modules at a time.

Tran-shipment

If vertical packaging modules need to be transported to the construction project site through secondary transportation after being transported to the centralized storage site by container or flatbed vehicle, the following points should be noted:

If forklift truck is used for transport, the forklift truck shall comply with the above requirements for unloading, and the forklift truck size shall be at least $\geq 3T$;

If you use a box truck or other type of vehicle, please use a carriage with guardrail, the height of the guardrail is not less than $2/3$ of the height of the module, and use fastening straps to secure the module to the carriage; modules should be placed closely with each other, and gaps should not be left.

If the vertical package is turned to horizontal by a turning machine, please note that the flat tray structure is used as the bearing unit of the module after turning over, and only the frame surface of the module can be used as the bearing surface of the module after turning over.

Retail packaging

If the modules are not filled when they are shipped, Topco uses wooden frames of the same size as the modules as packing fillers. The wooden frames are located in the middle of the packaging body, and the scattered packaging method is exactly the same as the integral packaging method.

Storage

Please store the modules in a dry and ventilated environment and place the modules on a relatively flat ground.

Ensure that the outer package of the modules is intact. Ensure that the pallets and packages are protected from moisture and direct sunlight in the storage area, and take waterproof (rain) measures.

If the modules are stored in an uncontrolled environment, they must not be stored for more than 3 months.

Long-term storage of modules is recommended to be stored in a standard warehouse. Check for module tilt anomalies periodically.

Do not soak the tray in water. Take drainage measures on the ground to prevent the wooden pallet from rotting or the ground from sinking after a rain.

Unpacking

Please confirm the product model, power, quantity and serial number according to the shipping mark posted on the container before unpacking. For vertical packaging, please carefully read the unpacking operation instructions and unpacking support assembly operation instructions, do not use other unpacking methods other than the unpacking operation instructions.

- ❖ Do not lift the wiring and junction box of the module, hold the frame while carrying.
- ❖ During handling, do not distort or bend modules due to operation or other weight.
- ❖ The number of modules stacked horizontally does not exceed 18.
- ❖ Do not rely on the backplane to support modules when moving or installing them.
- ❖ Do not contact the module with sharp objects to avoid damaging the module.
- ❖ Vertical packing and unpacking shall not be carried out on non-horizontal or soft ground;
- ❖ When vertical packing and unpacking, the operator shall not stand behind the reclining surface;
- ❖ After unpacking, do not place module electrical connectors near any unauthorized chemical substance.

Horizontal packaging

Applicable product series:

TPxxxPM5-66SA, TPxxxPM5-78SA, TPxxxPM5-60SB, TPxxxPM5-72SB, TPxxxPMB7-46SC, TPxxxPMB6-58SC

Horizontal packing and unpacking is the conventional packing method, which will not be specified here. If you have any questions in the process of unpacking, please contact Topco commercial department to provide specific information.

Vertical packaging

Applicable product series:

TPxxxPMB6-69SDC, TPxxxPMB6-68SDC, TPxxxPMB6-69SC, TPxxxPMB6-68SC

Unpacking method 1: unpacking with brackets

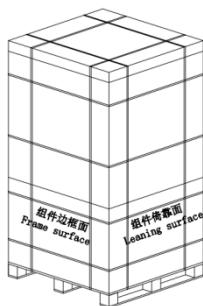

The unpacking modules are placed on a level floor

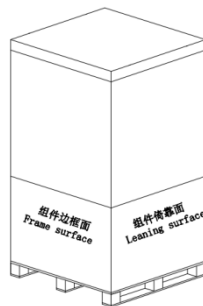

Remove the plastic wrap, wrapping film, cover and surface of the packing case

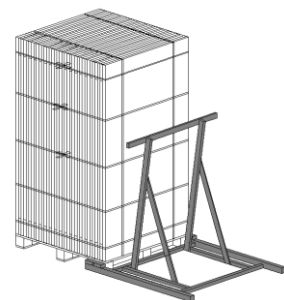

Place a support bracket on either of the recline surfaces of the assembly and remove the three transverse steel strips from the upper part of the assembly with a cutter

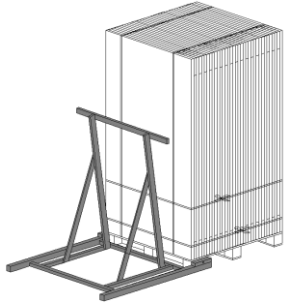

Two people stand on the frame surface of the module to hold the component, while the other person cuts the lower two transverse plastic steel packing belts

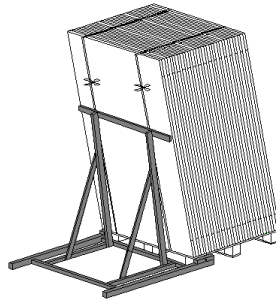

Gently push the assembly so that it leans against the support frame and remove the vertical steel strip

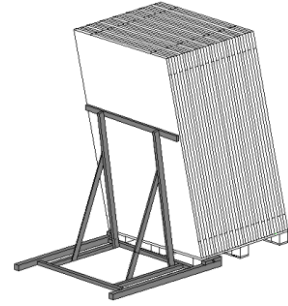

Remove all modules in sequence to complete module unpacking

Unpacking method 2: Rely on

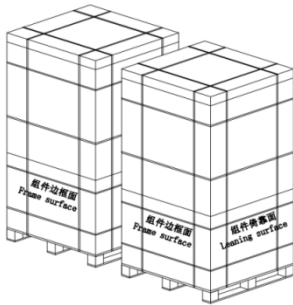

Unpacking the reclining surface needs to be close to a solid wall or another pallet of intact components of the same size

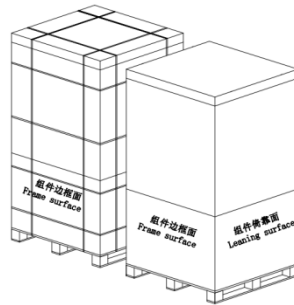

Remove the plastic wrap and wrapping film for the modules to be removed, and remove the cover and packing case

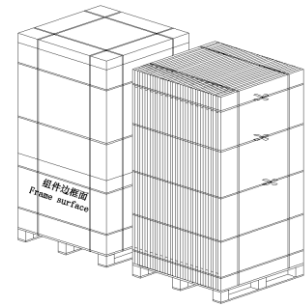

Use scissors to remove the three transverse steel strips from the upper part of the assembly

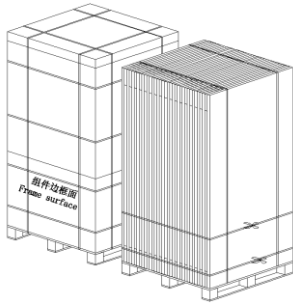

Two people stand on the frame surface of the module to hold the module, while the other person cuts the lower two transverse plastic steel packing belts

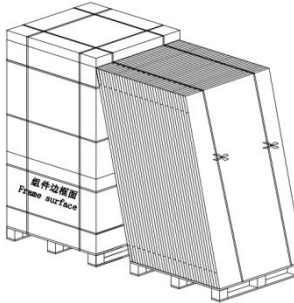

Gently push the module so that it leans against the support, removing the vertical strip of plastic steel

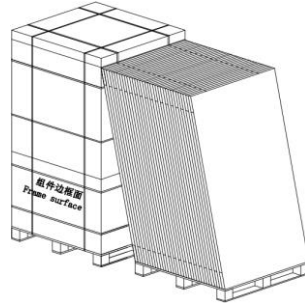

Remove all modules in sequence to complete module unpacking

5 Module Installation

Installation environment

- ❖ The module is recommended to be installed in an environment where the operating temperature ranges from -20°C to 50°C. The maximum operating temperature ranges from -40°C to 85°C, and the humidity is lower than 85%RH.
- ❖ When installing solar modules on a roof, it is also necessary to leave a safe working area between the edge of the roof and the outer edge of the photovoltaic module array.
- ❖ When modules are piled on the roof, the load of the roof should be rechecked, and the construction organization plan in accordance with the requirements of the code should be formulated.
- ❖ If in the northern hemisphere, usually choose the light facing south installation of the module. If you are in the southern hemisphere, you usually choose the light-facing north mounting of the module.
- ❖ when selecting module installation position, should choose can make full sunlight position, to avoid the module surface forms part or all of the shade (trees, buildings, clothing, tools, packing materials and other obstacles), because these objects on the module form the shadow, the shadow will cause loss of output power.
- ❖ The module should be installed in a well-ventilated place to ensure adequate air circulation on the back and side of the module to facilitate the timely release of heat generated when the module is working.
- ❖ When used in areas with high wind pressure and snow pressure, support fixed structures should be designed in strict accordance with local design specifications to ensure that the external load does not exceed the mechanical strength limit that the modules can bear.
- ❖ Topco's modules have passed the salt spray corrosion test of IEC61701, indicating that Topco modules can be installed in offshore or corrosive environments.
- ❖ At a place 50m to 500m away from the sea, corrosion may occur at the part where the frame of the module is connected to the support, or the part where the grounding is connected. Stainless steel or aluminum materials must be used to contact the photovoltaic module, and the installation part must be treated with anti-corrosion.
- ❖ Please consult the Topco technical support department for more information on the use of modules in special climates, such as an altitude greater than 2000m, heavy snow, severe hail storm, hurricane, etc.

Inclination Choice

The inclination Angle of the photovoltaic module refers to the included Angle between the photovoltaic module and the horizontal ground. Different projects choose different installation inclination Angle according to local conditions.

Modules connected in series of the same array must be in the same direction and Angle. Different installation directions and angles cause differences in the total amount of solar radiation absorbed by modules, resulting in a loss of output power, which reduces the operating efficiency of the system.

The maximum power is generated when the sunlight directly exposure to the modules. Consider the power output of the module in winter when selecting the best installation Angle.

In order to facilitate module cleaning and wash away dust on module surface when it rains, for detailed installation Angle, please follow the advice given by experienced PV module installers.

Machinery Installation

Ensure that the module installation strong enough, supporting system composed of the phalanx system components must be able to withstand the mechanical load pressure, appointed by its bracket installer must provide the guarantee, mounting bracket needed and static mechanics analysis ability of the third-party testing institutions to test, need to adopt international standards or national standards.

The mounting bracket of the component must be made of materials that are resistant to corrosion, rust and UV.

Modules must be securely mounted on system supports.

Do not drill additional mounting holes in the frame and glass. Otherwise, the module warranty will be invalid.

The support structure of modules has thermal expansion and cold contraction effect. To avoid affecting the performance and use of modules, it is recommended that the minimum distance between the two module is 10mm. To ensure good ventilation of modules and reduce load, it is recommended that the installation distance between two modules is 30mm.

In areas with heavy snow in the winter, choose a high mounting bracket so that the lowest point of the module is not covered by snow for a long time, and the lowest point of the module is high enough to prevent the module from being obscured by plants or trees.

The support surface of the installation bracket must be flat, without distortion or deformation, and there is no up and down dislocation between the connected brackets.

The assembly installation method should not result in electro-chemical corrosion between the aluminum frame and different metals.

Location Choice

Roof

When installing on a roof or building, ensure that they are securely secured and will not be damaged or dropped by strong winds or snow. Provide a special mounting bracket for roof installation if necessary. The building code used for roof installation should be checked to ensure that the building and structure to which the modules are installed have sufficient load-bearing and airtight properties. The roof through which the fixed modules are installed should be sealed to prevent rainwater leakage.

To facilitate operation, reduce water vapor condensation, and promote ventilation and heat dissipation for modules, ensure that the modules are parallel to the surface of the wall or roof of the building. The distance between the modules and the surface of the wall or roof is at least 115mm. In this way, the air circulation at the rear of the modules facilitates heat dissipation and prevents cable damage. When stacking modules, ensure that the modules are installed on A fireproof roof. The module has a fire rating of C and is suitable for installation on a roof with fire rating of A or higher.

For the roof system with heavy snow or snow record in the installation area, the customer shall support and reinforce the bottom module frame of the entire system to ensure that the bottom module is protected from top-down snow push and pressure damage and damage to the module caused by daytime snow melt and icing.

Struts

When installing modules on struts, select struts and module mounting brackets that can withstand the expected local

wind. The struts must have a solid foundation.

Ground

Select an appropriate installation height for ground installation to prevent the lower part of the module from being covered by snow for a long time in winter. Install the modules on a support of an appropriate height. Do not lay the modules directly on the ground. In addition, ensure that the minimum part of the module is not less than 900mm to avoid being obscured by plants or trees, to avoid being damaged by blown sand or being obscured by soil splashed by rain.

Wiring

Topco provides recommended connection modes for customers. If the connection modes required by the installation personnel are different from the recommended connection modes, please contact Topco commercial personnel to evaluate the feasibility of connection modes.

Photovoltaic modules can be connected in series to increase the series voltage, and connected in parallel to increase the series current. Please select a reasonable connection mode according to the electrical parameters of the inverter selected by the photovoltaic system and the maximum system voltage of the modules.

When connecting cables, pay attention to the polarity of the positive and negative terminals of modules.

For different types of components, Topco provides optional wire lengths to match different system wiring methods.

The following table describes the recommended system cabling methods.

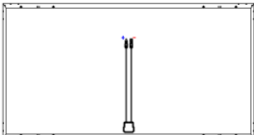
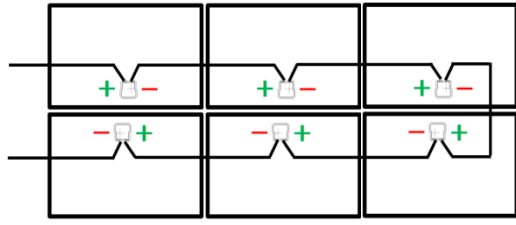
 <p>TPxxxPM5-66SA TPxxxPM5-78SA TPxxxPM5-60SB TPxxxPM5-72SB</p>	<p>Horizontal installation (double row, junction box inside)</p> <p>72/78 version of the total wire length is not less than 2400mm, 60/66 version of the total wire length is not less than 2000mm.</p> 
--	---

	<p>Horizontal installation (double row, junction box on the outside)</p> <p>72/78 version of the total wire length is not less than 2400mm, 60/66 version of the total wire length is not less than 2000mm.</p>
--	--

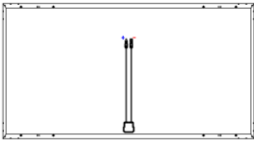
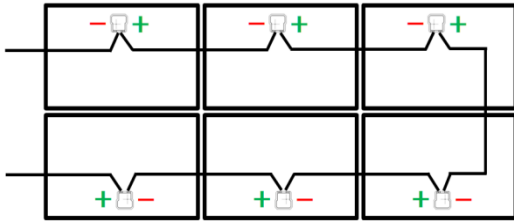
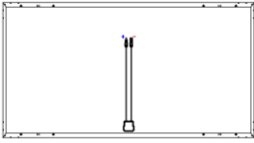
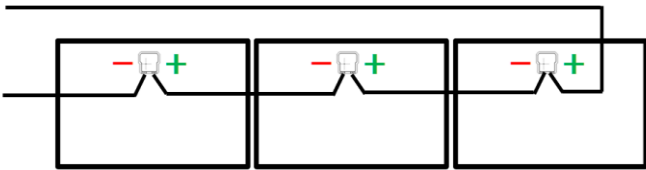
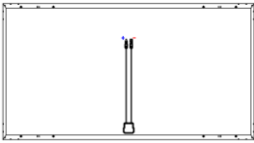
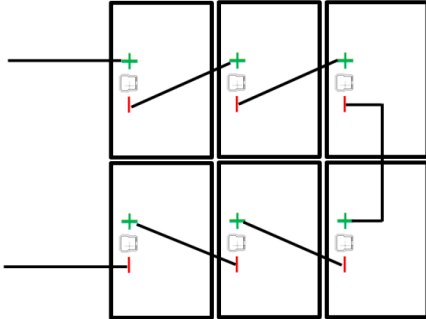
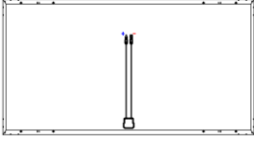
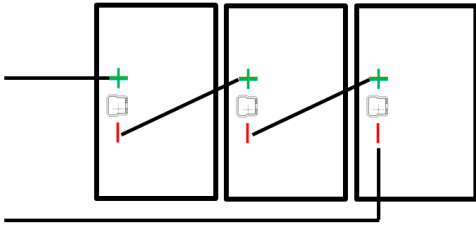
 <p>TPxxxPM5-66SA TPxxxPM5-78SA TPxxxPM5-60SB TPxxxPM5-72SB</p>	
 <p>TPxxxPM5-66SA TPxxxPM5-78SA TPxxxPM5-60SB TPxxxPM5-72SB</p>	<p>Horizontal installation (single row) 72/78 version of the total wire length is not less than 2400mm, 60/66 version of the total wire length is not less than 2000mm.</p> 
 <p>TPxxxPM5-66SA TPxxxPM5-78SA TPxxxPM5-60SB TPxxxPM5-72SB</p>	<p>Vertical installation (double row) 72/78 version of the total wire length is not less than 1400mm, each group shall add a not less than 900mm jumper wiring, 60/66 version of the total wire length is not less than 1400mm, each group shall add a not less than 500mm jumper wiring.</p> 
 <p>TPxxxPM5-66SA TPxxxPM5-78SA TPxxxPM5-60SB TPxxxPM5-72SB</p>	<p>Vertical installation (single row) 72/78 version of the total wire length is not less than 1400mm, 60/66 version of the total wire length is not less than 1400mm.</p> 
<p>Vertical mounting (head to tail connection) In this connection mode, TPxxxPMB6-68SDC/ TPxxxPMB6-68SC/ TPxxxPMB6-69SDC/ TPxxxPMB6-69SC the total wire length must be at least 1500mm. TPxxxPMB6-58SC/ TPxxxPMB7-46SC the total wire</p>	

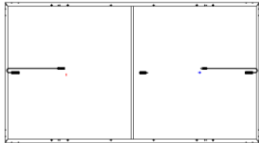
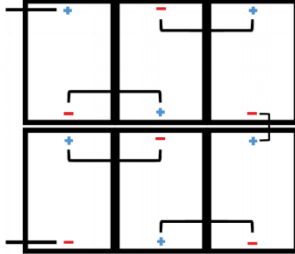
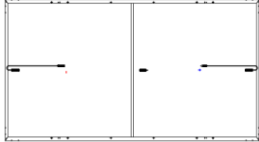
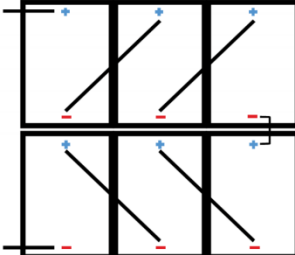
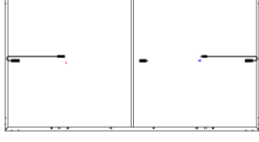
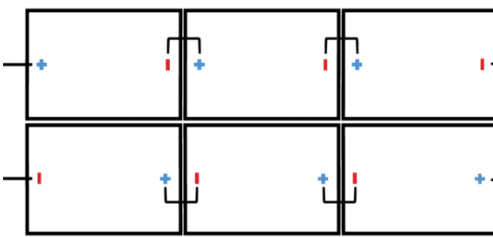
 <p>TPxxxPMB7-46SC TPxxxPMB6-58SC TPxxxPMB6-68SC TPxxxPMB6-68SDC TPxxxPMB6-69SC TPxxxPMB6-69SDC</p>	<p>length must be at least 1300mm , Pay attention to the positive and negative terminals and ensure that the modules are turned at intervals.</p> 
 <p>TPxxxPMB7-46SC TPxxxPMB6-58SC TPxxxPMB6-68SC TPxxxPMB6-68SDC TPxxxPMB6-69SC TPxxxPMB6-69SDC</p>	<p>Vertical installation (straight connection)</p> <p>The total wire length of this connection mode must be at least 2800mm. For TPxxxPMB7-46SC, the total wire length must be at least 2300 mm.</p> 
 <p>TPxxxPMB7-46SC TPxxxPMB6-58SC TPxxxPMB6-68SC TPxxxPMB6-68SDC TPxxxPMB6-69SC TPxxxPMB6-69SDC</p>	<p>Horizontal mounting (head to tail connection)</p> <p>This connection mode has the total wire length must be at least 400mm. Each group string needs to add a 1000mm jumper cable.</p> 

Note: 1. Total wire length means positive plus negative cables length.

2. On the premise of not affecting the overall design scheme of the system, it is recommended that the modules of the horizontal plate series (integrated wire box and located near the long side) be installed vertically, and the modules of the vertical plate series (split wire box and located near the short side) be installed horizontally, to avoid unnecessary power generation loss caused by ash accumulation at the bottom of the inclined installation.

6 Installation Guide

Modules must be installed according to the installation instructions to comply with IEC requirements.

Connections between modules and support systems can be installed using mounting holes in the frame, clamps

If the installation method used is different from the recommended installation method, please get approval from Topco. Otherwise, modules may be damaged and the warranty may be invalid.

In extreme weather conditions or user-defined installation methods, strengthen key connections to prevent damage to modules or system connections.

The loads described in this manual are test loads. According to IEC installation requirements, a factor of 1.5 should be considered when calculating the corresponding maximum design load. The design load of the project depends on the project location, local climate, support structure and related specifications. Support suppliers and professional engineers are responsible for determining the design load. For more detailed information, follow local laws and regulations as well as instructions from structural engineers.

Installation Method: Bolting

The modules are bolted to the support structure using mounting holes of the frame.

Each module must be securely fastened at a minimum of 4 points on two opposite sides.

Bolts and nuts M8 X 1.25-Grade 8.8 hot dip galvanized or A2-70 stainless steel should be used.

The yield strength of bolts and nuts must not be less than 450MPa.

According to bolt class, tightening torque of M8 coarse tooth bolt is 16~20Nm.

Installation in heavy snow or high wind load areas, use additional mounting holes.

Use stainless steel flat washers with thickness $\geq 1.5\text{mm}$ and diameter size $\geq 18\text{mm}$. (Please refer to the frame section drawing provided by Topco Solar energy to select the upper limit flat washer that can be operated)

Modules shall be bolted to the position of the following mounting holes according to the structure and load requirements:

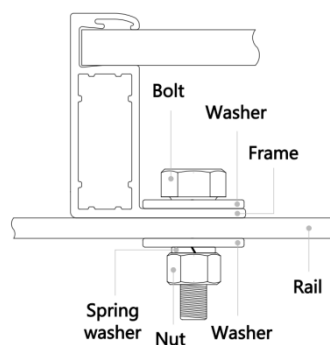
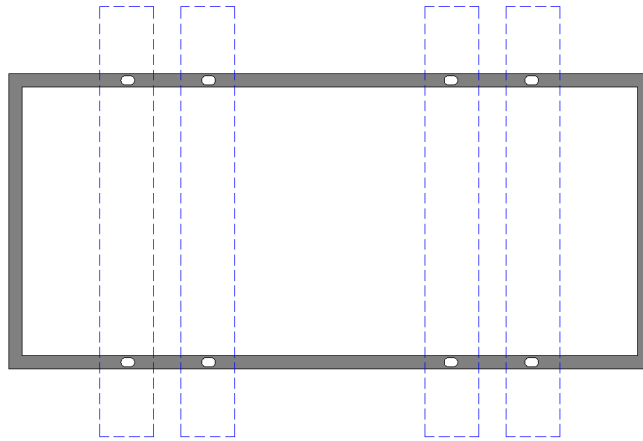

Figure 6. Bolt installation methods

Eight mounting hole installation (mounting hole size: 9*14mm)



Installation rail vertical to the long side of the module, applicable type:

TPxxxPM5-78SA	TPxxxPMB5-78SA	TPxxxPM5-72SB	TPxxxPMB5-72SB
TPxxxPM5-78SAF	TPxxxPMB5-78SAF	TPxxxPM5-72SBF	TPxxxPMB5-72SBF
TPxxxPM5-78SAS	TPxxxPMB5-78SAS	TPxxxPM5-72SBS	TPxxxPMB5-72SBS

Mechanical load: Front side ≤5400Pa, Rear side ≤2400Pa

Remark: The width of bolting installation surface of frame which called “C”side is 30mm.

Inner four mounting hole installation (mounting hole size: 9*14mm)

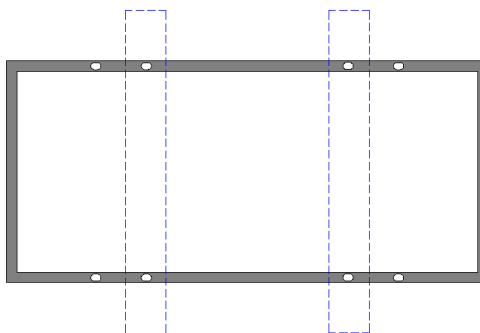

Installation rail vertical to the long side of the module, applicable type:

TPxxxPMB6-54SDC	TPxxxPMB6-57SDC	TPxxxPMB6-58SDC	TPxxxPMB6-65SDC
TPxxxPMB6-68SDC	TPxxxPMB6-69SDC		

Mechanical load: Front side ≤5400Pa, Rear side ≤2400Pa

Remark: The height of the frame which called “B”side is 35mm.

Installation method: Clamps

Use a certain number of clamps to secure the modules to the mounting rail. Topco recommends that fixtures be clamped to the frame of module.

The clamps shall be made of anodized aluminum alloy or stainless steel.

The length and thickness of the clamp recommended by Topco are ≥50mm and 3mm respectively.

The contact width between the clamps and the a side of the frame is in the range of 7 ~ 11 mm.

Install and tighten on the mounting rails with the torque specified by the mounting components manufacturer. The clamps is installed with $m 8 \times 1.25$ bolts and nuts. For M8 heavy thread bolts, the tightening torque should be between 16 Nm and 20 Nm depending on the bolt grade.

When installing the clamps, do not touch the front glass, and do not scratch or deform the aluminum frame during the installation process. At the same time, the clamps can not affect the operation of the module, and make sure that the drainage hole and the grounding hole are not blocked.

Each module requires at least four clamps to be secured, and at least two clamps for each long or short frame, depending on local application conditions (wind and snow conditions) , an additional number of clamps may be required to ensure that the modules and systems bear the corresponding loads, as shown in Figures 7.

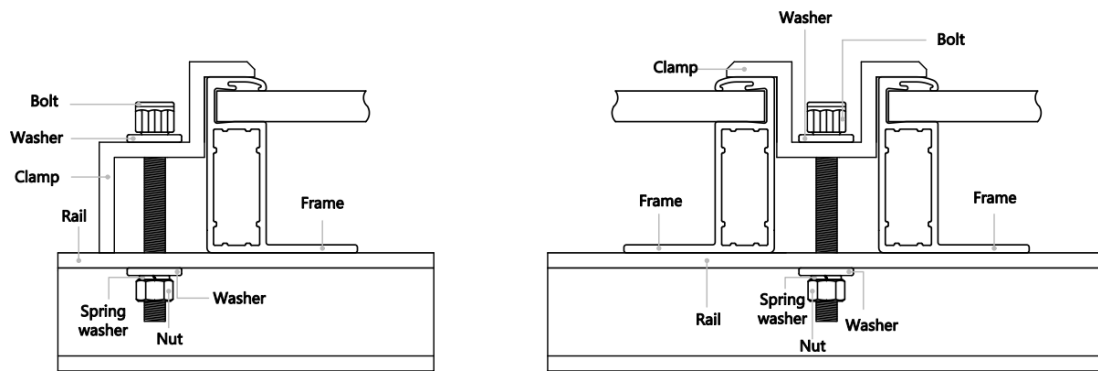

Figure 7. Specific installation of clamps

Clamps position is critical to the reliability of installation , center line must be installed as described in the following table according to structural and load requirements.

Four clamps mounting on long side of frame and rails perpendicularly to the long side frame

Module types	A Range(mm)	Max. Mechanical load (Pa)
TPxxxCM5-60S TPxxxPM5-60S	275-375	Front sides≤5400, Rear sides≤2400
TPxxxPM5-60SA	280-380	Front sides≤5400, Rear sides≤2400
TPxxxPM5-66S TPxxxPM5-66SA TPxxxPM5-66SAF	280-380	Front sides≤5400, Rear sides≤2400 Front sides≤3600, Rear sides≤3600

TPxxxPM5-66SAS TPxxxPMB5-66S TPxxxPMB5-66SA TPxxxPMB5-66SAF TPxxxPMB5-66SAS		
TPxxxPM5-60SB TPxxxPM5-60SBF TPxxxPM5-60SBS TPxxxPMB5-60SB TPxxxPMB5-60SBF TPxxxPMB5-60SBS	295-395	Front sides≤5400, Rear sides≤2400 Front sides≤3600, Rear sides≤3600
TPxxxPMB7-46SC TPxxxPMB7-46SCS TPxxxPMB7-46SCF	330-430	Front sides≤5400, Rear sides≤2400

Six Clamps mounting on long side of frame and rails perpendicularly to the long side frame , the middle rail is located in the center of the module

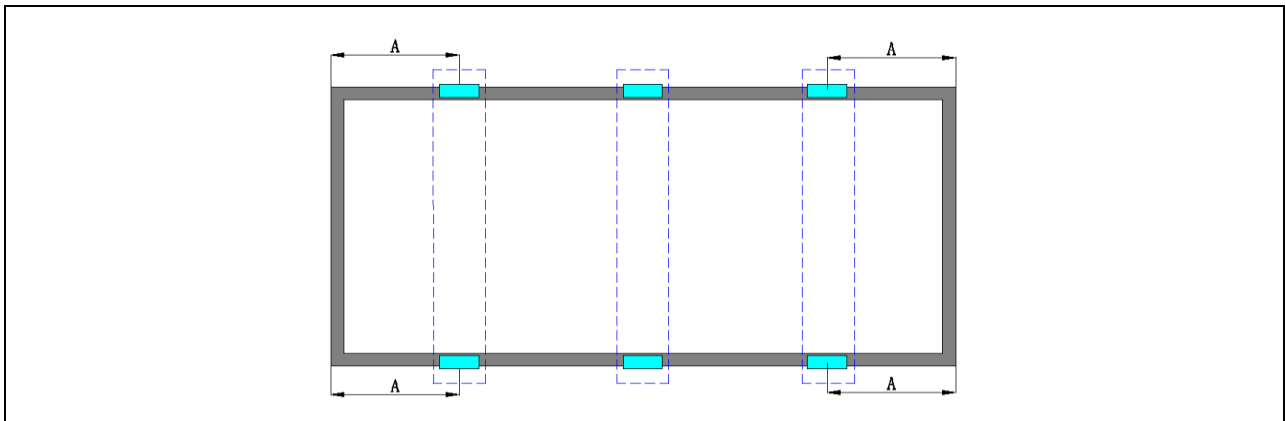

Module type	A Range(mm)	Max. Mechanical load (Pa)
TPxxxCM5-72S TPxxxPM5-72S	340-440	Front sides≤5400, Rear sides≤2400
TPxxxPM5-72SA	345-445	Front sides≤5400, Rear sides≤2400
TPxxxPM5-78S TPxxxPM5-78SA TPxxxPM5-78SAF TPxxxPM5-78SAS TPxxxPMB5-78S TPxxxPMB5-78SA TPxxxPMB5-78SAF TPxxxPMB5-78SAS	345-445	Front sides≤5400, Rear sides≤2400
TPxxxPM5-72SB TPxxxPM5-72SBF TPxxxPM5-72SBS TPxxxPMB5-72SB TPxxxPMB5-72SBF	360-460	Front sides≤5400, Rear sides≤2400

TPxxxPMB5-72SBS		
TPxxxPM5-66S TPxxxPM5-66SA TPxxxPM5-66SAF TPxxxPM5-66SAS TPxxxPMB5-66S TPxxxPMB5-66SA TPxxxPMB5-66SAF TPxxxPMB5-66SAS	280-380	Front sides≤5400, Rear sides≤2400 Front sides≤3600, Rear sides≤3600

Eight clamps mounting on long side of frame and rails perpendicularly to the long side frame

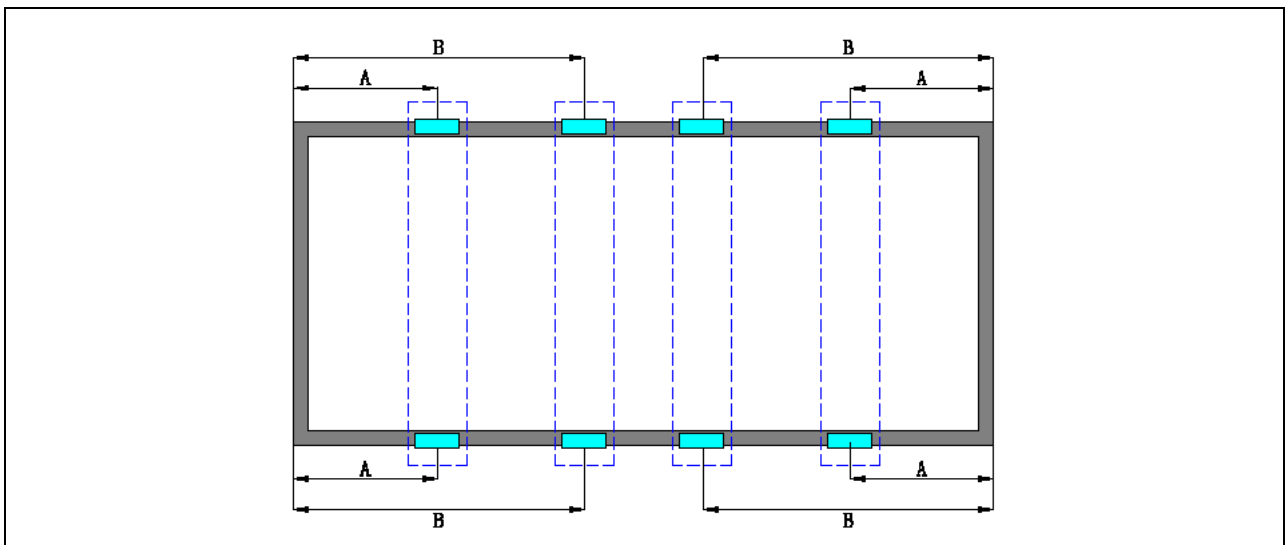

Module types	A Range(mm)	A+B Range(mm)	Max. Mechanical load(Pa)
TPxxxPM6-54SC TPxxxPMB6-54SC	355-455	495-595	Front sides≤5400, Rear sides≤2400
TPxxxPM6-57SC TPxxxPMB6-57SC	375-475	520-620	Front sides≤5400, Rear sides≤2400
TPxxxPM6-58SC TPxxxPMB6-58SC	380-480	525-625	Front sides≤5400, Rear sides≤2400
TPxxxPM6-65SC TPxxxPMB6-65SC	355-455	495-595	Front sides≤5400, Rear sides≤2400
TPxxxPM6-68SC TPxxxPMB6-68SC	375-475	520-620	Front sides≤5400, Rear sides≤2400
TPxxxPM6-69SC TPxxxPMB6-69SC	380-480	525-625	Front sides≤5400, Rear sides≤2400

7 Maintenance

Modules need to be inspected and maintained regularly, especially during the warranty period. To ensure optimum performance of the modules, the following maintenance measures are recommended.

Cleaning

When modules are working, there should not be environmental influence factors to cover shadows in the modules, such as other modules, supporting rail, plants, large number of dust etc., which may directly reduce the power output and may even cause regional hot-spot effect. Therefore clean the glass surface on a regular basis, clean modules take measures so as:

- ❖ The frequency of module cleaning depends on the speed of accumulation of dirt, the rain will be carried out on the module surface is clean under normal circumstances, but still need to use a soft sponge or cloth (either dry or touch water) clean the module, surface rough materials shall not be used for any case clean, and acid and alkali cleaner to remove dirt is blocked too.
- ❖ Avoid local heavy weight to the module during cleaning, which will lead to module glass deformation, damage the solar cells, lead to reduce the service life of modules.
- ❖ Clear snow on modules in a timely manner to avoid damage to modules caused by long-term snow accumulation and snow melting and freezing.
- ❖ Do not pierce the back-sheet when cleaning the back of the module.
- ❖ It is recommended to clean the modules in the early morning or evening when the light is not strong and the module temperature is low, especially in areas with high temperatures.
- ❖ Do not attempt to clean modules with features such as broken glass or the presence of exposed wires, which may be subject to electrical shock.

Visual inspection

Please carefully check the modules of the existence of visual defects, focusing on the following items:

- ❖ Check whether the module glass is broken.
- ❖ Check if the front of the module is obstructed by obstacles or foreign objects.
- ❖ Check the module negative-sheet whether there is hot, negative film raised, burn through the traces and so on.
- ❖ Check whether the cell bus-bar is corroded, whether encapsulation materials of the module has delamination, bubbles, etc.
- ❖ Check the tightness of the bolts and the electrical connections at the connection points between the modules and the supporting rail.

Inspection of connector and cable

It is advisable to carry out a preventive check every 6 months and check the following:

- ❖ Check Junction box adhesive for cracks or cracks.
- ❖ Check the connector interface sealing and whether there is loose, melt deformation, aging or corrode.
- ❖ Check that the cable connections are secure and that the modules are properly grounded.
- ❖ When module is found to be defective, consult a qualified service technician. If servicing is required, it should be serviced by a qualified service technician.

- ❖ Module exposure generates high voltages in the sun, so cover the modules with opaque material when servicing modules to prevent electrical shock.
- ❖ Note:
 1. If found in the maintenance of any problems, feedback to the professional service personnel for confirmation;
 2. If using maintenance and repair measures not included in this manual, consult your local dealer for professional support.

AMENDED EDITIONS AND DATES

Version 1.1 was released in January 2022.

Internal file number

Q/TP 1081.10 Shingled module installation manual V1.1